



ALTERNATIVES TO HIGH GWP IN REFRIGERATION AND AIR-CONDITIONING APPLICATIONS

Study funded by ADEME, AFCE and Uniclimate

FINAL REPORT

December 4 2013

Authors:

Denis CLODIC et Xueqin PAN - EReIE

Eric DEVIN, Thomas MICHINEAU - Cemafrroid

Stéphanie BARRAULT - ARMINES CES



Cemafrroid
L'expertise de la chaîne du froid



Copyright

Any representation or reproduction in whole or in part without the consent of the authors or their heirs or successors is illegal according to the Code of Intellectual Property (Art. L 122-4) and constitutes an infringement punishable under the Criminal Code. Only are allowed (art. 122-5) copies or reproductions strictly reserved for private use and not intended for collective use, as well as analyzes and short quotations justified by the critical pedagogical character, or information the work to which they are incorporated, subject, however, to compliance with the provisions of Articles L122-10 to L122-12 of the Code, relating to reprographic reproduction

TABLE OF CONTENTS

EXECUTIVE SUMMARY	5
GLOSSARY	7
TECHNICAL SUMMARY	9
Context	11
Scope objective of the document	11
Target audience	11
Benefit for the reader	11
Keywords	11
1. SCOPE OF THE STUDY	13
1.1 Purpose of this report	13
1.2 Sponsors	13
1.3 Presentation of organizations that made the study	14
2. METHODOLOGICAL APPROACH OF THE STUDY	15
2.1 Segmentation by application sector and sub-sector	15
2.2 Information sources	18
2.3 Presentation format of results	18
2.4 Usage of the content of factsheets and indicators	19
2.4.1 Factsheets on refrigerant data	19
2.4.2 Application factsheets	19
2.4.3 Technical factsheets of alternatives to vapor compression	23
3. SYNTHESIS OF THE REGULATORY AND STANDARDIZATION CORPUS IN FRANCE AND IN EUROPE	24
3.1 Introduction	24
3.2 Regulations applicable to refrigeration and air-conditioning installations	24
3.2.1 Regulation linked to the impact of greenhouse effect (regulation 842/2006)	24
3.2.2 Regulation applicable to EXplosive ATmospheres (ATEX) / Directive 94/9/EC and 99/92/EC	27
3.2.3 Regulations applicable to Equipments under Pressure (PED)	29
3.2.4 Regulations applicable to Classified Installations for Environmental Protection (ICPE)	31
3.2.5 Regulations applicable to public buildings (ERP).....	34
3.3 Standards applicable to refrigeration and air-conditioning installations	35
3.3.1 Series of EN 378 Standard – Refrigeration systems and heat pumps – Safety and environmental requirements.....	35
3.3.2 Standard ASHRAE 34 - Designation and safety classification of refrigerants	37
3.3.3 Industry standards applicable to installations or equipments	37
3.4 Eco-design Directive 2009/125/EC	39
4. REFRIGERANTS OF VAPOR COMPRESSION SYSTEMS	40
4.1 Introduction	40
4.2 Origin of the choice of CFCs and HCFCs as refrigerants	40
4.3 From chlorofluorocarbons (CFCs) to hydrofluorocarbons (HFCs)	41
4.4 The revival of refrigerants: hydrocarbons, ammonia, and CO₂	45
4.5 Unsaturated hydrofluorocarbons (said HFOs)	48
4.6 HFCs with GWP < 750	51
4.7 Blends of HFOs and HFCs	53
5. ANALYSIS OF ALTERNATIVES BY KEY SECTOR OF REFRIGERATION AND AIR CONDITIONING	57
5.1 Refrigerant banks in each application sector	57
5.2 Domestic refrigerators and freezers	60
5.3 Commercial refrigeration – Display cases and cold rooms for large and medium sales areas	61
5.3.1 Presentation of the sector.....	61
5.3.2 Alternatives to direct expansion systems using R-404A in low-temperature only or low-temperature and medium-temperature refrigeration systems(factsheet FC1)	62
5.3.3 Alternatives to stand-alone using HFC-134a	63
5.3.4 Alternatives to condensing units using R-404A.....	63
5.3.5 Conclusions.....	63
5.4 Refrigerated transport	64
5.5 Refrigeration in food processes	65
5.6 Air-to-air conditioning	69
5.7 Residential heat pumps (HPs)	70
5.8 Chillers	71

5.9 Mobile air conditioning	72
6. DATA ON TECHNOLOGIES ALTERNATIVE TO COMPRESSION SYSTEMS CONTAINING HIGH-GWP HFCS	73
6.1.1 Absorption refrigeration equipment.....	74
6.1.2 Adsorption refrigeration equipment.....	76
6.1.3 Brayton cycle refrigeration equipment.....	78
6.1.4 Stirling refrigeration equipment.....	80
6.1.5 Refrigeration equipment with pulsed tube.....	82
6.1.6 Thermo-acoustic refrigeration equipment.....	84
6.1.7 Magneto-caloric refrigeration equipment	86
6.1.8 Thermo-electric (TE) refrigeration equipment.....	88
6.1.9 Dry ice systems and liquid nitrogen systems	90
7. SYNTHESIS OF INTERVIEWS	93
7.1 Key users, representative organizations and related entities by sector and sub-sector	93
7.2 Profile of respondents	93
7.3 Results of the survey	94
ANNEX 1: CONSORTIUM PRESENTATION	96
ANNEX 2: LIST OF THE CONSORTIUM EXPERTS PARTICIPANTS TO THE STUDY.....	99
ANNEX 3: LIST OF COMPANIES INTERVIEWED WITHIN THE SCOPE OF THE STUDY.....	103
ANNEX 4: LIST OF REPORTS AND PUBLICATIONS USED WITHIN THE SCOPE OF THE STUDY	104
ANNEX 5: LIST OF REGULATORY TEXTS.....	105
ANNEX 6: LIST OF STANDARDS AND RECOMMENDATIONS	106
ANNEX 7: VALUES OF GWPS OF REFRIGERANTS	107
ANNEX 8: COMPARISON OF THE SEGMENTATION ADOPTED WITH THAT PROPOSED BY SKM [SKM12]	109
ANNEX 9: SECTOR ANALYSIS OF BANKS AND DEMANDS FOR MAINTENANCE OF REFRIGERATION AND AIR- CONDITIONING INSTALLATIONS OF THE FRENCH INSTALLED BASE	112
A9 – 1 R-404A and R-507AA.....	112
A9 – 2 R-410A	114
A9 – 3 R-407C	116
A9 – 4 HFC-134a.....	118

EXECUTIVE SUMMARY

This report intends to present an overview of the current use of refrigerants in France and within the European and international context. The European context is that of the updating of the Regulation 842/2006 on fluorinated refrigerants so-called “F-Gas”, but also that of the international context where the U.S. and China agreed on a reduction schedule of high-GWP HFCs. The U.S. and China propose that the implementation of this schedule be established in parallel to the HCFC-production phase-out schedule, and that those two schedules are followed by the Parties to the Montreal Protocol. This proposal, strongly opposed by India (and by Brazil to a lesser extent), indicates a possible international consensus on the necessity to define a phase-down schedule of **high-GWP** HFC refrigerants.

To be mentioned that the definition of “high GWP” in Europe is related to the massive use of HFC-134a (GWP = 1370) since the Directive 40/2006 prohibits charging in mobile air-conditioning systems for new platforms as of 2011 and complete prohibition for new vehicles as of January 2017. One can deduce that the 150 GWP threshold by the same Directive 40/2006 can be considered as “low”. A large number of refrigerants present GWPs between 1 and 20 and can be qualified by very low. **In fact, “low” and “high” make sense for GWPs only when referred to overall released quantities.** The issue is the mass released to the atmosphere times the GWP. Moreover regulations under preparation tend to settle a schedule for the reduction of the quantities of fluorinated products placed on the market, expressed in CO₂ equivalent. Those products can be aerosols, blowing agents, and mainly refrigerants that are dominant (80 to 90%) for quantities of fluorinated substances placed on the market.

This report addresses only refrigerants and refrigeration and air-conditioning systems, and analyzes demands and thus the desirable schedule to eliminate progressively “high”-GWP refrigerants. Refrigeration technologies other than vapor compression are analyzed; it indicates that niches exist for these technologies, some significant, but that the order of magnitude are totally different compared to vapor compression systems. The number of refrigeration and air-conditioning systems worldwide can be estimated to 2.7 billion, of which 1.5 billion of domestic refrigerators; technologies other than vapor compression systems, mainly absorption systems, represent hundreds of thousands of units (0.03% of the overall installed base) including hotel minibars.

Replacement options are analyzed by application sector and take into account inorganic fluids such as ammonia and CO₂ as well as hydrocarbons and fluorinated molecules, either unsaturated (HFO Hydro-fluoro-olefins) or with low GWP such as HFC-152a (GWP = 133) or medium GWP such as HFC-32 (GWP = 176). Those molecules can be used either as pure refrigerants or in blends to obtain desirable properties of use. Now let's go straight to the point by defining sectors where replacement refrigerants are known or even established.

In European **domestic refrigeration**, HFC-134a is already massively (90 to 95%) replaced by isobutane because charges are low (<150 g) and the safety design of refrigerators has been reviewed.

More generally, **hydrocarbons** are used in small commercial refrigeration and with moderate charges in **direct expansion systems** with charges up to 1.5 kg, and even more in indirect expansion systems. Those options require ATEX equipment and a thorough analysis of associated safety aspects. Except for domestic refrigeration, where the system is fully welded, the generalization of hydrocarbon systems seems risky for charges higher than 150 g, unless the system is fully welded and the charge is related to the volume of the room where the equipment is installed.

In mobile air conditioning, even if the controversy between CO₂ proponents and R-1234yf advocates continues in Europe, the technical viability of R-1234yf is proven and the mass production of mobile air-conditioning systems to be charged with this refrigerant is starting.

In low-temperature (-35 to -38°C) centralized commercial refrigeration, corresponding to supermarkets and large supermarkets, low-temperature CO₂ operating in cascade with a refrigerant adapted to the

medium temperature (-10°C) constitutes an already proven alternative. In the future, the medium-temperature refrigerant can be either R-1234yf, or CO₂ for latitudes where the number of hours with outdoor temperatures higher than 25°C are limited (10% of the year) because energy efficiency losses of CO₂ are significant due to its very low critical temperature (31°C).

In food processing, ammonia is already largely used; the cascade architecture, with CO₂ at the low temperature (from -35°C to -50°C) and ammonia at the medium temperature (-20°C to -10°C), allows ammonia charge limitation. The installation lifetime can be of 30 years, investment costs can be very significant, retrofit from HFC to ammonia is impossible (copper and ammonia are not compatible), and so changes take time. Some location configurations (near residential buildings, ...) may forbid the use of ammonia.

Beyond those facts, for other applications, we are in a period of abundance of technical options at very different maturity levels. Sectors where a company is the end user have to be distinguished of sectors where a citizen is the end user, as well as sectors where globalization makes the choice global, and the decision makers (original equipment manufacturers) are outside national borders. Air-to-air-conditioning systems are the typical example, with a global market in the range of 60 millions of units dominated by Japanese, American, Korean, and now Chinese companies. The two refrigerants massively used in air-to-air conditioning systems are HCFC-22 in developing countries, and R-410A in developed countries. The largest number of replacement refrigerants is proposed in this application sector. The change for hydrocarbons is not likely to be chosen because of safety issues on such equipment installed base. Candidate refrigerants are HFC-32 itself or HFC-32-based blends (GWP = 716) with one of the available HFO: R-1234yf or R-1234ze. GWPs of such refrigerant blends are around 500. The question (that can be modeled) is: is GWP 500 acceptable on the long-term? To be mentioned that those refrigerant blends are moderately flammable and that safety standards have to be adapted.

Heat pumps in residential buildings are either air-to-air reverse air-conditioning systems, and options are identical to those described above, or air-to-water systems, the most common in France; the refrigerant is essentially R-410A and candidate refrigerants are the same: HFC-32 and HFC/HFO blends based on HFC-32. **For heat pumps in industry**, depending on the temperature levels, candidate refrigerants for the future are R-1234ze and R-1233zd.

Beyond those sectors, major in terms of refrigerant quantities and to cover all sectors, the analysis is made by application sector: reference systems are described, high-GWP HFCs are identified, and for those systems, existing alternatives are analyzed as well as those under development, according to available information. The information is synthesized in « Application Factsheet ».

Direct and indirect expansion systems: in parallel with the refrigerant choice issue for a defined thermodynamic system, a significant degree of freedom exists in several application sectors: the use of heat transfer fluid (HTF). The thermodynamic system is no longer in direct contact with the final ambience; chillers constitute a typical example, and so are glycol-water circuits in commercial refrigeration or industrial refrigeration. CO₂ itself can also be used as a HTF. In commercial refrigeration, in air-conditioning in non-residential building, and in residential heat pumps, this indirect architecture makes sense, limits drastically the refrigerant charge, and gives new options for the refrigerant choice, especially for the management of flammability or toxicity. Indirect expansion systems can be designed to maintain energy efficiency at least equal to that of the reference in direct expansion systems.

About 15 years have been necessary to phase out respectively CFCs, then HCFCs for new installations, and manage some existing installations over ten additional years, while knowing that replacement options were known and that the regulation was setting a schedule of end of production. Here, we are in a schedule of strong reduction of CO₂ equivalent metric tonnes of fluorinated refrigerants authorized to be put on the market, which opens more options and therefore more difficult trade-offs with end users and providers of technical options.

GLOSSARY

Volumetric capacity (kJ/m^3): Cooling capacity (or heating capacity for a heat pump) produced by the volumetric flow rate of the compressor in the reference conditions for condensation and evaporation temperatures. This value allows the comparison of refrigerants with regard to the compressor sizes and indirectly the price of the installation.

COP: Coefficient of Performance; it is the ratio between the useful capacity (cooling capacity for a refrigeration equipment, heating for a heat pump) and the power consumed by the compressor. The COP can also include the power consumption of pumps and fans depending on the boundary conditions of the balance.

Seasonal COP: this COP is used to take into account variations of the outdoor temperatures and makes sense to analyze the efficiency of systems operating at partial load.

CFC: Chloro-Fluoro-Carbons, molecules derived of methane or ethane, where all hydrogen atoms are substituted by chlorine or fluorine atoms.

CTP: Professional Technical Notebook (Cahiers Techniques Professionnels)

Drop-in: Retrofit of installation corresponding only to the change of refrigerant, without any other modifications (neither components, nor oil).

Emissions (of refrigerant): release to the atmosphere of refrigerant whatever the cause. The annual report on fluorinated refrigerant emissions is required by the Climate Convention (1992).

ERP: Public Building (Etablissement recevant du public)

HCFC: Hydro-Chloro-Fluoro-Carbons, molecules derived of methane or ethane; where the substitution of hydrogen atoms by chlorine or fluorine atoms is partial.

HFC: Hydro -Fluro-Carbons, molecules derived of methane or ethane; where the substitution of hydrogen atoms by fluorine atoms is partial.

HCFO : Hydro-Chloro-Fluoro-Olefins, molecules derived of propylene where the substitution of hydrogen atoms by chlorine or fluorine atoms is incomplete. The double ethylene bond weakens this molecule in the atmosphere where it is decomposed by the hydroxyl radical -OH .

HFO: Hydro-Fluoro-Olefins, molecules derived of propylene where the substitution of hydrogen atoms by fluorine atoms is incomplete. The double ethylene bond weakens this molecule in the atmosphere where it is decomposed by the hydroxyl radical -OH .

ICPE: Installation classified for environmental protection (Installation classée pour la protection de l'environnement)

GWP: Global Warming Potential. CO_2 is the reference molecule, its GWP is 1 whatever the integration horizon taking into account its lifetime in the atmosphere. The GWP of other molecules is a ratio to the GWP of CO_2 that takes into account the atmospheric lifetime of the product and its absorption value in the infrared spectrum in the atmosphere.

ODP: Ozone Depleting Potential. The ODP is a ratio of the ozonide capacity of one molecule to that of CFC-11 (because its measurements in the atmosphere were made in 1950). By definition, the CFC-11 ODP is 1. The scale is thus the capacity of a molecule to destroy a quantity of ozone molecules greater or smaller than the capacity of CFC-11 destruction.

Retrofit or retrofit: retrofit of an installation in view of the refrigerant change needing at least installation rinse and oil change (the most simple case) but that may also require adjustments and component changes, making the retrofit far much expansive than a simple drop-in.

RT: Thermal building regulation (Réglementation thermique)

TFA: Trifluoroacetic Acid, decomposition product of unsaturated HFCs (HFO). This molecule is also produced naturally by oceans; its maximum concentrations that can be imagined by release of future HFOs used have no significant impact on marine ecosystems.

TECHNICAL SUMMARY

The **methodological approach** of this study consists in:

- describing refrigerants used according to the specifications of each application,
- collecting and processing the most recent information on alternative solutions either of low GWP refrigerants or technologies alternative to vapor compression
- synthesizing applicable regulations and standards
- interviewing end users, equipment manufacturers, and refrigerant producers
- establishing synthetic Factsheet on high-GWP refrigerants and their possible replacement candidates
- establishing Factsheet by application
- synthesizing and comparing all available or under development alternatives for each of the 33 reference systems identified in the nine refrigeration and air-conditioning application sector in "Application Factsheet".

Replacement options are analyzed by application sector and takes into account inorganic refrigerants such as ammonia and CO₂ as well as hydrocarbons and fluorinated molecules, either unsaturated (HFOs Hydro-fluoro-olefins), or with low GWP such as HFC-152a (GWP = 133), or medium GWP such as HFC-32 (GWP = 716). Those molecules can be used as pure refrigerants or in blends to obtain desirable usage properties.

Direct and indirect expansion systems: in parallel with the refrigerant choice for a defined thermodynamic system, a number of options exist in several application sectors: the use of heat transfer fluid. The thermodynamic system is not in contact with the ambience. Chillers are a typical example as well as glycol-water circuits in commercial refrigeration. CO₂ can also be used as an HTF. This architecture makes sense, limits drastically the refrigerant charge, and gives new options for refrigerant choices, especially for the flammability or toxicity management.

For domestic refrigeration, in Europe, HFC-134a is already massively (90 to 95%) replaced by isobutane because charges are low (< 150 g) and the design of refrigerator safety has been reviewed.

For **large-capacity installations in large supermarkets,** the future concept will limit drastically the refrigerant charge at the medium-temperature refrigeration (-12°C) via a secondary indirect loop and using either HFC-134a (short term) or CO₂ or R-1234yf (medium term), the low temperature (-35 to -30°C) operating with CO₂ in direct expansion. The same concept can be applied identically to supermarkets where, according to the latitude and number of hours where outdoor air temperature is higher than 25°C, the system can operate with CO₂ only.

For condensation units, which are generic equipment, it is likely that refrigerant blends with GWP around 300 will be substituted to R-404A, because ATEX precautions for refrigerant blends with very low flammability are significantly different of those required by hydrocarbons. Stand-alone equipment will have the choice between the same blends, propane, isobutane, and R-1234yf.

In **food processing,** ammonia is already widely used; to limit the ammonia charge, the cascade architecture is used: CO₂ at the low temperature (from -35°C to -50°C) and ammonia at the medium temperature (-20°C to -10°C). The installation lifetimes can be 30 years, investments can be very high, the retrofit from HFC to ammonia is not possible (incompatibility between copper and ammonia), and thus changes take time. Some configurations of sites (close to residential area) make sometime the use of ammonia difficult.

Refrigerated transports are direct expansion systems using either HFC-134a or R-404A. Technical options for the replacement of those fluids, are:

- on one side R-1234yf for HFC-134a,

- for R-404A, an international company proposes already an autonomous system operating with CO₂, but refrigerant blends with GWP around 300 and containing HFC-32 and R-1234yf or R-1234ze are under study; an AHRI report is dedicated to this application.

Air conditioning: the annual global market is in the range of 60 million units, dominated by Japanese, American, Korean, and now Chinese companies. Two refrigerants are massively used: HCFC-22 in developing countries and R-410A in developed countries. This sector offers the largest number of refrigerant substitutes. Because of security concerns on such a large equipment installed base, no one can think of a general use of hydrocarbons. Refrigerant candidates are HFC-32 itself, refrigerant blends still containing HFC-32 and one of the available HFOs, R-1234yf or R-1234ze. GWPs of those blends are around 500.

Residential heat pumps are either air-to-air reverse air-conditioning systems, and options are identical to those described above, or air-to-water systems; the refrigerant is essentially R-410A and candidate refrigerants are the same: HFC-32 and HFC/HFO blends based on HFC-32. **For industrial heat pumps**, depending on the temperature levels, candidate refrigerants for the future are R-1234ze and R-1233zd.

Small and medium capacities R-407C chillers: refrigerant candidates are those based on HFC-32 and GWPs in the range of 300 because HFC-32 concentration remains equal or lower than 40%.

R-410A chillers: the same refrigerant-blend candidates are proposed with 70%-concentration of HFC-32 and so GWPs in the range of 500.

Since chillers can be compact and installed out of occupied spaces, the **use of ammonia** is possible, from a typical refrigerating capacity higher than 250 kW, so as to compensate the additional costs due to heat exchangers. It is also possible **to use propane R-290**, which is proposed by some European companies.

For refrigerating capacities higher than 350 kW, two segments have to be distinguished:

- **screw chillers**, where the choice of refrigerants includes R-407C, R-410A, and HFC-134a, and where reference refrigerants for the future can be ammonia, HFO/HFC blends, and R-1234ze
- **centrifugal chillers** operating only with HFC-134a. For those groups tests are well advanced and R-1234ze seems to be the reference refrigerant for the future.

Mobile air conditioning: even if the controversy between CO₂ proponents and R-1234yf advocates continues in Europe, the technical viability of R-1234yf is proven and the mass production of mobile air-conditioning systems to be charged with this refrigerant is starting.

The review of **alternative technologies** shows that niches exist for certain technologies but none of them can, currently, take market shares where those technologies can be at par with vapor compression systems. Only absorption systems, born at the same time as the refrigeration process itself, keep significant market segments for water chillers.

It took about 15 years to phase out respectively CFCs, and then HCFCs for new installations and manage some existing facilities over an additional ten years, the replacement options were known and regulations had set a phase-out production schedule. Here we are in a strong restriction schedule of CO₂ equivalent metric tonnes of fluorinated refrigerants, leaving both more degrees of freedom and therefore more delicate balance between end users and providers of technical options.

CONTEXT

The European context is the update of the regulation 842/2006 on fluorinated gases named “F-Gas”, but also that of the international context where USA and China have come to an agreement on a schedule for the reduction of high-GWP HFCs. USA and China propose that the monitoring of this schedule be established in parallel with the schedule for the end of production of HCFCs, and that those two schedules be applied by the Parties to the Montreal Protocol. This proposal indicates a possible international consensus on the need to determine a schedule for the reduction of **high-GWP** HCFCs.

SCOPE OBJECTIVE OF THE DOCUMENT

This document is intended to establish the current maturity of technical options whether on low GWP refrigerant for vapor compression systems or alternative technologies to those systems.

The regulation and standard contexts is reminded.

Refrigeration and air-conditioning applications using currently high-GWP refrigerants are presented and stakes in terms of quantities stored in equipments and maintenance needs over the typical lifetime of those installations are detailed. Available and undergoing developments are presented, for known refrigerants (CO₂, ammoniac, hydrocarbons) or new HFOs: R-1234yf or R-1234ze, as well as blends of those refrigerants with either low GWP HFC, HFC-152a (GWP = 133) or medium GWP, HFC-32 (GWP = 716).

TARGET AUDIENCE

- Decision-makers of each refrigeration and air-conditioning application sector
- Officers of the French government and the European Commission in charge of updating the European regulation 842/2006
- Company executives in charge of regulatory changes associated with choice of refrigerants
- Refrigeration and air-conditioning professional associations
- Consultants of enterprises specialized in the analysis of environmental impacts of refrigerants
- Non-governmental organizations specialized in environmental issues
- International organizations such as UNEP.

BENEFIT FOR THE READER

- Have an analysis on options for refrigerant candidates to replace high-GWP refrigerants and their maturity, for each refrigeration and air conditioning application sector
- Have an updated information on low-GWP refrigerants and on alternative technologies to vapor compression
- Have an updated and synthesized information on safety standards and the European regulation

KEYWORDS

Refrigerant, HFC, HFO, CO₂, ammonia, hydrocarbons, GWP, vapor compression, low-GWP refrigerants, F-GAS regulation, absorption, adsorption, thermo-electricity, thermo-acoustic refrigeration, Stirling machine, pulsed tube, magnetic refrigeration, air cycle, COP, ATEX, safety standards, PED, heat pump, air conditioning, refrigeration system.

1. SCOPE OF THE STUDY

This study aims at the presentation of a current use of refrigerants in France within the European and international context. The European context is the update of the regulation 842/2006 on fluorinated gases, the so-called “F-Gas”, but also that of the international context where the U.S. and China agreed on a schedule for the reduction of high GWP HFCs.

USA and China propose that the monitoring of this schedule be established in parallel with the schedule for the end of production of HCFCs, and that those two schedules be applied by the Parties to the Montreal Protocol. This proposal vigorously opposed by India (and Brazil to a lesser extent), indicates however a possible international consensus on the need to determine a schedule for the reduction of **high-GWP** HCFCs.

The definition of « **high GWP** » in Europe, is based on the massive use of HFC-134a (GWP = 1370) since the Directive 40/2006 forbade the charge of mobile air-conditioning systems for new platforms as soon as 2011, and the complete interdiction for new vehicles as of January 1st, 2017. One can deduce that the GWP threshold of 150 fixed by the same Directive 40/2006 is considered as “low”. A large number of refrigerants present GWP between 1 and 20, and can be qualified of very low. **In fact “low” and “high” make sense for GWPs only when related to the released quantities of refrigerants.** The issue is indeed the released refrigerant mass times its GWP. Besides, regulations under preparation aim at a reduction schedule of the commercialization of fluorinated products with a GWP expressed in CO₂ equivalent.

1.1 PURPOSE OF THIS REPORT

AFCE is a non-profit association that promotes a responsible use of refrigerants. As such it follows the regulation developments related to HFCs and, in general, concerning all refrigeration techniques.

Taking into account the current revision of the F-Gas in Europe, that plans a rapid phase down, and even interdictions of use in certain applications, the AFCE has requested EReIE, the Cemafruid and ARMINES to realize an independent study, based on a technical expertise of alternatives for all HVAC and industrial refrigeration applications using high-GWP HFCs.

Regulatory and standard limits, the maturity degree of alternative technologies, their time for industrialization and appropriation by markets are highlighted in this study.

Thus the content of this report presents information related to the market share of HFCs and their alternatives, in terms of refrigerants as well as in terms of technologies. Its objective is to provide a tool for stakeholders so they can prepare means and schedules to manage a phase down of high-GWP HFCs.

1.2 SPONSORS

**Alliance Froid Climatisation
Environnement**
55b, Rue Porte Rabel
61300 L'AIGLE

ADEME
20, avenue du Grésillé
BP 90406
49004 ANGERS Cedex 01

Uniclimate
11-17, rue de l'Amiral Hamelin
75783 PARIS CEDEX 16

1.3 PRESENTATION OF ORGANIZATIONS THAT MADE THE STUDY

The consortium is constituted by:

- EReIE, company specialized in the sector of refrigeration techniques, coordinator
- CEMAFROID, a company specialized in the cold chain
- A research organization (ARMINES, CES laboratory)

Those three organizations have complementary competencies and personnel skilled in refrigeration systems, a worldwide reputation on inventories of refrigerants, and a relationship network with all stakeholders: ministries, European Commission, chemical companies specialized in refrigerants, large HVAC companies, large business users, trade associations

Moreover, the activities of these organizations are independent of the manufacturing and marketing of technologies under study, ensuring an impartial and independent assessment of the state of the art techniques.

Their activities are detailed in Annex 1.

2. METHODOLOGICAL APPROACH OF THE STUDY

2.1 SEGMENTATION BY APPLICATION SECTOR AND SUB-SECTOR

Refrigeration and air-conditioning applications can be structured in 8 large application sectors:

- domestic refrigeration,
- commercial refrigeration,
- refrigerated transports,
- industrial refrigeration that can be divided in two parts
 - food industry, and
 - industrial processes,
- air conditioning,
- chillers,
- heat pumps, and
- mobile air conditioning.

Within those sectors, different types of installations or equipments are used, differentiated by various technologies (ex: centrifugal compressor, volumetric compressor), structures of different systems (direct expansion system, indirect expansion system including one or even two secondary loops) or different refrigerants.

The objective of this study being the analysis of available alternatives to high-GWP HFCs, for each application sector different types of installations have been inventoried and the most used high-GWP used has been identified. A list of reference systems, corresponding to the most “critical” case of the sector, systems using HFCs with the highest GWP can thus be established (Table 2.1); for these systems available and under-development alternatives are analyzed. Available alternatives may be part of systems inventoried in the sector analysis. It has to be underlined that, in terms of refrigerants, HFC-134a will be part of high-GWP refrigerant used in some sectors (e.g. domestic refrigeration) or available alternatives operating with lower GWP refrigerants when the sector use mainly very high-GWP HFCs, such as R-404A (e.g. commercial refrigeration).

Each reference system is thus linked to an application sector and sub-sectors that are more particularly concerned are detailed. For each reference system, available and under development alternatives are investigated and synthesized in “**Application Factsheet**” (see Section 2.4). This factsheet mentions not only alternatives in terms of *refrigerant used* but also in terms of *technology* and, where appropriate, in terms of *drop-in*¹ or *retrofit*² options.

In the nine selected sectors, **33 reference systems** have been identified and are listed in Table 2.1, specifying sub-sectors concerned.

¹ Drop-in: Installation retrofit corresponding only to refrigerant change, without any other modifications (neither component, nor oil).

² Retrofit: Installation retrofit in view of the refrigerant change requiring at least rinsing and oil change (most simple case) but that can also require adjustments and change of spare parts, making the retrofit much more expansive than a simple drop-in.

Table 2-1 - Selected segmentation and identified reference systems.

Application sector	Reference system	High-GWP HFCs concerned	Sub-sectors concerned
Domestic refrigeration	Sealed refrigeration system factory charged	HFC-134a	Refrigerators only and refrigerators freezers
	Hermetic-freezer factory charged	HFC-134a	Freezers
Commercial refrigeration	Direct or indirect centralized systems (medium temperature only)	R-404A	Supermarkets
	Direct or indirect centralized systems (medium and low temperatures)	R-404A	Large supermarkets and Supermarkets
	Condensing unit for display cases	R-404A	Small convenience stores
	Stand-alone systems for display cases <i>Low temperature (1/3)</i> <i>Medium temperature (2/3)</i>	R-404A	Small convenience stores
Refrigerated vehicles	Direct-drive for trucks and vans	R-404A	Road transport
	Self-powered units	R-404A	Road transport
	Self-powered containers	HFC-134a	Marine transport
	Direct expansion systems for reefers	R-404A	Marine transport
Food industry	Medium-temperature direct expansion systems for <i>(small or medium of high capacity)</i>	R-404A	Milk industry Chocolate factory Some warehouses Beer and wine Soft drinks
	Low-temperature direct expansion systems using R-404A, (including freezing tunnels) or medium and low <i>(small or medium of high capacity)</i>	R-404A	Meat industry Slaughters Frozen industry Chilled dishes Warehouses
	Medium-temperature indirect expansion system	R-404A	Meat industry Slaughters Frozen industry Chilled dishes Warehouses
	Flooded-evaporator system, low temperature	R-404A	Meat industry Slaughters Frozen industry Chilled dishes Warehouses
	<i>Medium or high capacity chillers</i>	<i>R-404A</i>	<i>Taken into account in the dedicated sector</i>
Refrigeration in industry	Direct expansion systems (Medium and low temperatures)	HFC-134a, R-507AA	Chemical industry Pharmaceutical industry Rubber industry
Air conditioning	Self-contained systems for equipment type "Window", "Console" or "Mobile"	R-410A	Domestic air conditioning
	Small-capacity splits (P < 17,5kW)	R-410A	Domestic air conditioning

	Small-capacity multi-splits (P < 17,5kW)	R-410A	Non-residential air conditioning
	Roof tops	R-410A	Commercial air conditioning
	Specific cabinets	R-410A	Commercial air conditioning
	VRV system (Variable refrigerant volume)	R-410A	Commercial air conditioning
	Multi-split with P > 17,5KW (centralized systems)	R-410A	Non-residential air conditioning
Chillers	Low-capacity volumetric chillers (P < 50 kW)	R-410A, HFC-134a	Residential air conditioning
	Medium-capacity volumetric chillers (50 < P < 350 kW)	R-410A	Residential air conditioning or industrial process
	High-capacity volumetric chillers (P > 350 kW)	R-410A or R-407C	Residential air conditioning or industrial process
	Centrifugal chillers	HFC-134a	Residential air conditioning or industrial process
Residential heat pumps	Air-to-water heat pumps	R-410A	Residential HVAC
	Water-to-water or glycol water-to-water heat pumps	R-410A	Residential HVAC
	Ground-to-floor heat pumps	R-410A or R-407C	Residential HVAC
	Ground-to-water heat pumps	R-410A or R-407C	Residential HVAC
Mobile air conditioning	Air-conditioning system for cars	HFC-134a	Cars, vans, truck cabins
	Air-conditioning system for trains	R-407C or R-410A	Locomotive, wagon
	Air-conditioning system for buses	HFC-134a	Cars and buses

For information, a comparison with the classification proposed by the SKM study is given in Annex 8.

2.2 INFORMATION SOURCES

The study on available and under development alternatives to systems using high-GWP HFCs in all refrigeration and air-conditioning applications is based on:

- the analysis of synthetic reports on existing technologies and refrigerants used in these systems in France and in Europe, on one side and, the study of first available reports and papers on tests of HFCs or HFOs developed newly or the use of non-fluorinated refrigerants in some applications
- A series of interviews of installation owners, contractors, OEMs, refrigerant producers, and technical experts.

Main information sources are, on the one hand, national and international references on technologies, equipment installed base and refrigerants used in refrigeration and air-conditioning applications, such as:

- the report of the Technical Option Committee of UNEP [TOC11]
- studies on inventories (France [BAR12], Europe [CLO11])
- preparatory reports for the revision of the European regulation by Oko-Research [SCH11], EReI et ARMINES/CES [CLO11] or SKM Enviro [SKM12]
- on the other hand, analyses of first low-GWP refrigerants developed, carried out within international programs such as the AREP program (Low-GWP Alternative Refrigerants Evaluation Program) of AHRI (Air-Conditioning, Heating & Refrigeration Institute) [ARE13].

Last, other publications or communications, either presentation of new refrigerants available from producers or specific analysis on a sector (e.g. [PER13] on commercial refrigeration) are also used. The list of references is given in Annex 4.

Some information have been obtained via interviews and then compared to results of technical or scientific publications, and to thermodynamic data characterizing refrigerants, so as to make a consistent synthesis by application sector.

Upon the request of some participants, the content of interviews is confidential and is used only in a general way in the synthesis.

2.3 PRESENTATION FORMAT OF RESULTS

Results of the study are presented in synthetic factsheet of three types:

- **REFRIGERANT FACTSHEET** including essential information on physical properties, costs and possible barriers or restrictions of use of these refrigerants (Section 4)
- **APPLICATION FACTSHEET** that presents, for each identified reference system, the description of existing systems, high-GWP halogenated refrigerant(s) used, the analysis of available alternatives and those of techniques under development or under study. For each alternative, the analysis compared to the reference is summarized via a multi-criteria radar-type.
- **TECHNOLOGICAL FACTSHEET** presenting different types of refrigeration production techniques (Section 6).

Because of their format (A3), Application factsheets are presented in Annex 10. These factsheets are completed by explanations (Section 5) so as to consolidate data and any required information for subsequent interpretation.

2.4 USAGE OF THE CONTENT OF FACTSHEETS AND INDICATORS

One of the main objectives of the study is to provide a synthetic tool allowing the aggregation of all standardization or regulatory information required to understand the availability status on one hand of low-GWP refrigerants and on the other hand of refrigeration technologies alternative to vapor compression.

Thus this report constitutes a documentary base composed of synthetic factsheets organized according to the following outlines.

2.4.1 Factsheets on refrigerant data

These factsheets are established for all refrigerants used in vapor compression systems. They provide the reader with main physical properties of refrigerants. They also include:

- A brief analysis of costs that integrate the direct cost of the refrigerant, depending on its synthesis or production mode, and possible indirect costs that imply its conditions of use (pressure impact, material compatibility, flammability characteristics...).
- a synthesis of barriers and restrictions of uses which origin is usually linked to European or national regulations that apply depending on the charge or the application.

Format sample of a refrigerant factsheet:

Ammonia NH ₃	R-717
Main characteristics	GWP: 0, T _{critical} : 132.3°C Normal boiling point: -33°C R-717 (ammonia) is a pure substance, safety classification B2 (toxic, low flammability) ODP = 0.
Marketing extent	R-717 is used since the 19 th century, as soon as refrigeration started; it is still widely used in food processes and since 1990 its use has been extended to medium capacity chillers (a hundred in Europe) and in very few centralized systems in commercial refrigeration via heat transfer fluids (4 to 5).
Energy efficiency (taking into account ambient conditions)	R-717 presents thermodynamic properties favorable to evaporation temperatures higher than -33°C and otherwise require to use two-stage systems. Its volumetric capacity is similar to that of HCFC-22. However, its discharge temperatures are relatively higher.
Costs, profitability (referred to a reference)	The cost of ammonia itself is low (5 €/kg). However, the impossibility to use copper entails a significant additional cost and larger heat exchange surfaces (all things being equal). These additional costs penalize mainly small and medium-capacity systems, up to 200 kW _{cooling} typically.
Barriers and restrictions (safety, energy efficiency, etc.)	Barriers consist in the low availability of components for low capacities. The necessary specific training of technicians to maintain charge and recover this refrigerant. The ammonia toxicity leads to the obligatory use of indirect systems in commercial refrigeration with machinery rooms specifically designed for ammonia. In Europe, ammonia is classified under the Seveso Section (Section 1136 of the Environment Code), which makes declaration mandatory (charges between 150 kg and 1.5 t) and authorization for charges larger than 1.5 t.

Reminder of main physical properties

Items related to the commercialization of the refrigerant, its energy efficiency, costs of the refrigerant itself, and barriers and restrictions of use.

2.4.2 Application factsheets

These factsheets are established for each reference system selected in the segmentation defined in the analyses of refrigeration and air-conditioning sectors. Application factsheets are presented in Section 5. Each factsheet includes three distinct parts for each application.

- The first part, entitled “DESCRIPTION OF THE REFERENCE SYSTEM” is composed of:
 - a brief description of the use and the temperature required by the sector
 - the refrigerant the most commonly used when the reference technique is based on the use of high-GWP HFC
 - GWP values, the average charge of the equipment, an estimated of the equipment installed base in France and in Europe
 - Justification of the choice of the refrigerant used with regard to the sector and its requirement in terms of specific standard
 - A summary of the regulations applicable to the sector in France and Europe.

- The second part entitled “EXISTING ALTERNATIVE TECHNIQUES” is composed of:
 - A brief presentation of the technical principle of substitution: this part can use refrigeration techniques based:
 - Either on compression systems operating with other refrigerants than the reference one
 - Or on other techniques (cryogenic, eutectics...): when the solution consists in the substitution of a compression system by a passive cooling source, additional information are provided on methods for the cold storage conditioning
 - an estimation of the installed base of current equipment, in France and in Europe, key stakeholders and the application specific regulation
 - technical-economical parameters for the comparison of the alternative solution to the initial one:
 - GWP value, considering also the refrigerant charge when this criterion is of importance
 - estimated energy efficiency based on the technical consensus of stakeholders interviewed for rating solutions. The criterion is then rated between 0 and 6 on the radar (see below) between the solution considered as the most effective and what is considered the less appropriate
 - technique availability by distinction of solutions already on the market, field-test solutions, and solutions under study or research
 - barriers to the generalization of the solution: either in terms of regulation of technique
 - context favorable to the implementation of the solution
 - a radar-type multi-criteria indicator, allowing the evaluation of the proposed alternative and the comparison of various alternatives together.

The image shows a 'Fiche Application' form with three main sections:

- Part 1:** A table for application details, including fields for 'Nom de l'application', 'Secteur de l'application', 'Description', 'Type de réfrigérant', 'GWP', 'Temps de service', 'Niveau de bruit', 'Niveau de vibration', 'Niveau de sécurité', 'Niveau de maintenance', 'Niveau de coût', 'Niveau de performance', 'Niveau de fiabilité', 'Niveau de disponibilité', 'Niveau de flexibilité', 'Niveau de compatibilité', 'Niveau de sécurité', 'Niveau de maintenance', 'Niveau de coût', 'Niveau de performance', 'Niveau de fiabilité', 'Niveau de disponibilité', 'Niveau de flexibilité', 'Niveau de compatibilité'.
- Part 2:** Three radar charts for multicriteria ranking, comparing different alternatives across various criteria.
- Part 3:** Three radar charts for multicriteria ranking, comparing different alternatives across various criteria.

Presentation of the application by sector and sub-sector, brief description and target temperature range

Characteristics of high-GWP HFCs used, synthesis of the regulation applicable to the sector.

Alternative techniques proven by demonstrators or prototypes, or directly available

Indicators for multicriteria ranking

Alternative techniques under study or development (laboratory or field test)

Indicators for multicriteria ranking

- The third part entitled “ALTERNATIVE TECHNIQUES UNDER DEVELOPMENT” is composed of data identical to the ones collected for existing alternatives, except data on installed base that have no reason to be and are replaced by:
 - identification of operational prototypes, pilots or field-test equipment
 - date of market availability when it can be estimated: this date is evaluated according to information collected from manufacturers or refrigerant producers during interviews.

For Application factsheets, the different alternative solutions are noted via a **multicriteria radar-type indicator**.

The indicator is constituted of a graphical representation of 6 criteria evaluated on a scale from 0 to 6. Values of each criterion increase when the criterion deviates from a favorable situation of the proposed alternative compared to characteristics of the original solution (reference system).

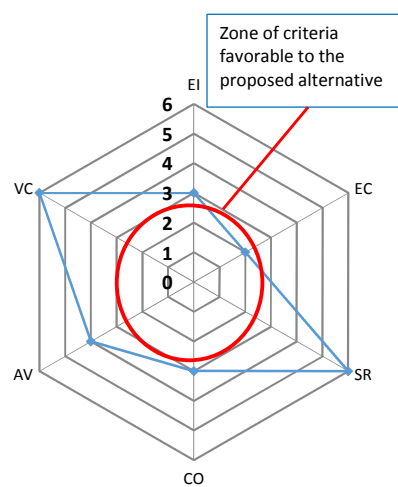

Figure 2.1 « Radar » ranking system.

In general, solutions offering all criteria with values lower or equal to 3 (graph included in a circle of radius 3, represented Figure 2.1) are considered as pertinent alternatives. When the graph representing the solution overlaps the circle, it is up to the reader to estimate benefits and limits of the concerned alternative with regard to the regulatory and economical context of the application sector and possibly the geographical area.

Criteria are as follows.

EI (Environmental Impact) – the GWP (Global Warming Potential) is used to compare the environmental impact of a replacement refrigerant for systems with an equivalent refrigerant charge. When considering the introduction of indirect expansion systems, the charge reduction will be associated with the consideration of the GWP in the EI ranking. GWPs are classified according to the following conventional nomenclature:

- 1 = very low (< 10)
- 2 = low (< 150)
- 3 = medium (< 750)
- 4 = high (> 750)
- 5 = very high (> 1500)
- 6 = extremely high (> 2500)

EC - Energy Consumption: this criterion is evaluated on the basis of lessons learned and results available in the literature. However, in a number of cases, comparisons of installations are misleading because all conditions are not equivalent. This is true for example, for commercial

refrigeration where it is often difficult to obtain comparative results of tests performed in laboratory. For this reason, the criterion is evaluated by ranking the various available alternatives and the reference technique. This ranking is then broken down on the criterion scale between 0 and 6, from the less energy consumption solution to the worse.

SR – Safety risks: this criterion relies on the classification of the standards ASHRAE 34 and EN 378, and by integrating the new classes of risk currently under discussion within standardization ad hoc groups. The risk is estimated based on the refrigerant flammability and toxicity. For a given application, standards EN 378 and ASHRAE 15 give criteria of acceptability or rejection of an alternative for a given application depending on the refrigerant charge. If applicability standards imply refusal of the solution, this fact is mentioned in the barriers related to the extension of the concerned alternative. This classification is presented by two alphanumeric characters (e.g. A2); the capital letter corresponds to the toxicity and the number to the flammability.

Classification according to toxicity

- Group A for which there is not proof of toxicity of refrigerants for concentrations lower or equal to 400 ppm ;
- Group B for which toxicity proofs exist for concentrations lower than 400 ppm.

Classification according to flammability

- Group 1: the refrigerant does not allow flame propagation in air at 21°C and 101 kPa;
- Group 2: the refrigerant has a lower flammability limit higher than 0.10 kg/m³ at 21°C and 101 kPa and a heat of combustion lower than 19 kJ/kg ;
- Group 3: the refrigerant is high flammable with a lower flammability limit lower or equal to 0.10 kg/m³ at 21°C and 101 kPa or a heat of combustion higher or equal to 19 kJ/kg.

Table 2.2 Equivalences between safety classes and SR ranking.

Standard class	Criterion value
0 = Class A1	0
A2L (class under creation)	2
A2 and B2	4
A3 and B3	6

CO – Cost of the option (maintenance not included): the cost is evaluated with regard to objective elements such as the nature of material used in the design of refrigeration equipment or safety systems required for example by the use of a flammable refrigerant. Maintenance costs or amortization costs are not considered by this indicator. The criterion is evaluated by raking costs of different available alternatives and the reference technique according to expert advices. This ranking is then broken on the criterion scale from 0 to 6. This raking is subject to change when such an alternative in development reaches industrialized scale.

AV – Availability: the availability is evaluated between 0 (industrialized level) up to 6 (laboratory study). An intermediate ranking assesses the existence of the implementation of this alternative for field tests. Field test means to have fully operational equipment substituting a reference solution under normal use and over a representative time operation of the concerned application.

VC – Volumetric capacity (kJ/m³)

This is the ratio of the refrigerating capacity in kJ/s (or heating for a heat pump) to the displacement of 1 m³/s of the compression volume. This volumetric capacity characterizes a refrigerant for defined condensation and evaporation temperatures. The highest the volumetric capacity, the smallest the compressor size for an identical rotation speed.

Criteria and associated values are summarized in Table 2.3.

Table 2.3 Criteria and associated values.

Criteria	Code	Values					
		1	2	3	4	5	6
GWP	EI	Very low <10	Low (<150)	Medium (< 750)	High (>750)	Very high (>1500)	Extremely high (> 2500)
Energy consumption	EC	Low		Medium		High	
Safety risk (according to EN-378 standard)	SR	A1	A2L		A2/B2		A3/B3
Cost of the solution (maintenance not included)	CO	Low		Medium		High	
Availability	AV	Industrialized		Prototype (field test)		Laboratory	
Volumetric capacity	VC	Sufficient		Medium		Insufficient	

2.4.3 Technical factsheets of alternatives to vapor compression

6.1.1 Absorption refrigeration equipment

Figure 6.2 LiBr-absorption equipment (Trane). Figure 6.3 Principle lay-out of a double-effect equipment (Trane).

Absorption equipments exist since the invention of refrigeration equipments (around 1850). Absorption preceded compression systems. Both pairs, refrigerant and absorbent, which have dominated and still dominate the market of absorption equipments are:

- Water as refrigerant and water-lithium bromide solution as absorbent
- Ammonia as refrigerant and the water-ammonia solution as absorbent.

Water–Lithium bromide
 Water-lithium bromide absorption chillers are, in general, equipment with cooling capacities higher than 350 kW and up to several megawatts (see Figure 6.2). The sole exceptions are equipment manufactured by the YASAKI group of which equipment starts around 50 kW cooling capacity. Water-lithium bromide equipments evaporate water at 2°C and operate under partial pressure (7 mbar), which implies very large volumes because of the vapor steam density at 2°C, which is of 5 g/m³.

As mentioned in Trane documents, that manufacture absorption and compression chillers, absorption represents in the range of 0.5% of the global market of large-capacity chillers.

Table 6.1 Sales of water-lithium bromide absorption equipment in China (Chen 07).

Year	1996	1997	1998	1999	2000	2001	2002	2003	2004	2005
Direct-fired type	1230	1341	1529	1352	2091	2385	3052	2785	4200	5600
Total	3249	3575	2780	2600	3289	3845	4320	3838	5500	6917

As shown in Table 6.1, China as well as Japan and Korea, manufacture and use a installed base of several tens of thousands of these chillers ; most of them are gas-fired (direct-fired in Table 6.1) others operate with steam as heat source. The coefficient of performance (COP) of such units, for evaporation temperature of 2°C and condensation of 35°C, varies between 1 and 1.2. For these three countries, absorption machines allow air conditioning via direct use of the gas network or industrial utilities and not the electrical network during peak hours. Japan, in the 80s, made a significant work to improve energy efficiency of these equipments with double effect, raising the

Scientific name of the refrigeration production principle

Brief technical history

Application sector

3. SYNTHESIS OF THE REGULATORY AND STANDARDIZATION CORPUS IN FRANCE AND IN EUROPE

3.1 INTRODUCTION

This section presents main regulations applicable to refrigeration installations. These regulations can be:

- EC regulations directly applicable within Member states; these regulations are often completed by national regulation, in which case, the EC regulation plus national provisions apply and, if contradictions exist, and, in case of conflict between the texts, the most demanding text applies.
- European directives that formalize State requirements. They must be transcribed within a given period these guidelines in the case of national legislation (transposition into national law of the Directives) with, in general, a detail adapted to the structures of the concerned state. These guidelines, called the new approach, facilitate the use of standards which, while not mandatory, provide a tool for presumption of conformity of a product with the essential requirements of a product. They lead to a conformity marking (CE marking supplemented by additional particulars necessary) allowing a manufacturer to market the product, which is the subject of an EC declaration of conformity throughout Europe, and no state may add technical barrier to trade. Directives govern new products or equipments. National rules supplement these European regulations for equipment in operation. For high-capacity refrigeration equipment, the notion of equipment is problematic because often they are based on systems involving several manufacturers of sub-systems and professionals in charge of the assembly.
- National documents issued by law (decrees, implementing order ...). These texts apply in general to controls of operating equipment or overarching regulations related to safety.

3.2 REGULATIONS APPLICABLE TO REFRIGERATION AND AIR-CONDITIONING INSTALLATIONS

European directives here below are not summarized in next sections, but have to be taken into account for all refrigerating equipment.

- Directive 2006/42/CE “Machines”
- Directive 2006/95/CE “Low Tension”
- Directive 2004/108/CE “Electro-magnetic compatibility (EMC) »

These directives set out the essential safety requirements aiming at:

- Safety of persons, goods and environment
- Free circulation of products throughout Europe.

Harmonized European standards (EN) are established to satisfy essential requirements of the different directives.

3.2.1 Regulation linked to the impact of greenhouse effect (regulation 842/2006)

Regulation (EC) 842/2006

The European regulation in force in terms of fluorinated gases aiming at the reduction of greenhouse-gas emissions, in accordance with the Kyoto Protocol, consists of two main legislative acts:

- Regulation (EC) no. 842/2006 concerning stationary equipments and focuses on the prevention of leaks during the use and at end of life of equipment; a small number of interdictions concern fluorinated gases used in specialized applications)

- Directive 2006/40/CE, related to mobile air-conditioning systems, introduces a restriction on the use of fluorinated gases with GWP greater than 150.

Its translation in French law is made by article 543-75 à 543-125 of the Code of the Environment.

The objective of Regulation (EC) no. 842/2006 is to reduce emissions of fluorinated gases by:

- incentive containment of refrigerants in systems where they are used
- obligation to perform regular leak control, at least once a year
- obligation to install leak detection systems for installations containing more than 300 kg of fluorinated gases
- obligation to recover refrigerants at equipment servicing and end of life
- obligation to implement (by the member states) training and certification of personnel carrying out leak checks, recovery, recycling, reclamation and destruction of fluorinated gases.

In order to improve the monitoring of fluorinated gases and their emissions, the following requirements are also stipulated:

- keeping records of the quantities and types of fluids used
- labelling of equipments and products containing fluorinated gases (gas type and quantity)
- reporting of quantities of fluorinated gases produced, imported and exported (as well as applications in which they were used and projected emissions) and recycled quantities, reclaimed or destroyed

This regulation is complemented by ten regulations of the Commission establishing the template of reports, the type of labelling and additional mandatory labelling, requirements for the leak detection, prescriptions in terms of training and certification programs, as well as the notification model of these programs.

Regulation (EC) 1005/2009

The regulation (EC) 1005/2009, related to substances that deplete the ozone layer, replaced the regulation (EC) 2037/2000 established after the Montreal Protocol.

In summary, concerning HCFCs, regulation (EC) 1005/2009 establishes mainly that:

- the production of HCFCs is authorized until 31/12/2019 but must follow a schedule of progressive reduction based on the production level reference of 1997 (from 35% over the period from 2010 to 2013 to 7% from 2017 to 2019)
- the import of HCFCs is prohibited except for reconditioning prior to export (*interdiction also of recycled or reclaimed HCFCs*)
- the commercialization of recycled HCFCs is authorized until 31/12/2014 for the maintenance and servicing of equipments

Concerning the use of recycled or reclaimed HCFCs:

- the use of recycled HCFCs is authorized providing labelling of cylinders containing the refrigerant (lot number and address of the recycling company)
- the use of recycled HCFCs is authorized until 31/12/2014 but only by the operator or the owner for whom the refrigerant has been recovered
- the use of recycled or reclaimed HCFCs shall be tracked, by enterprise, in a register recording the suppliers of reclaimed HCFC or source of recycled HCFCs, with a precise monitoring of quantities for equipment having a refrigerant charge larger than 3 kg

Concerning the limitation of emissions of installations operating with HCFCs:

- companies shall take any possible measures to prevent and limit leaks of HCFCs (annual leak detection at the minimum, frequency increases with the charge, quick repair of leaks, register of the installation monitoring)

- during maintenance and prior decommissioning of equipments, HCFCs have to be recovered prior to be destroyed, recycled or reclaimed by qualified personnel (member states have to define the minimum level).

Revision of regulation (EC) 842/2006

On December 16th, 2013, the Trilogue between the Parliament, the Commission and the Council reached to a compromise text which is summarized below.

Proposition of revision by the Commission

The proposition presented by the European Commission on November 7, 2012, has been established in view of the replacement of the regulation (EC) 842/2006 to ease the objectives of greenhouse-gas emission reduction in Europe by 2030, more efficiently and at lower cost. It is based on the last released reports, namely:

- ✓ The fourth assessment report of IPCC, which confirms the need to limit the raise of the global temperature at 2°C, which requires, according to the European Council, to reduce greenhouse-gas emissions from 80 to 95% in 2050 referred to the 1990 level in all sectors, in particular that of fluorinated gases
- ✓ The analysis of the application of the F-Gas regulation in force by the Commission (Report on the application, effects and adequacy of the regulation related to certain fluorinated greenhouse gases, no. 842/2006), which concluded that this regulation needed to be improved and to be fully applied by all member states
- ✓ A preliminary study to the regulation (Okoresearch report) shown that the use of substitutes to fluorinated gases could allow the reduction of annual equivalent CO₂ emissions by 2/3 by 2030 “for a relatively low cost”.

The proposed revision requests to reduce the use of high-GWP fluorinated gases to the benefit of other fluids referred to “as energy efficient and safe”, while maintaining the objectives of improving the containment of installations and the refrigerant recovery at end of life of equipments originally provided by Regulation 842/2006.

The Commission considers that this new regulation should facilitate the development of new refrigerants and technologies and, from a political point of view, should anticipate the possibility of reduction of the global production and consumption of HFCs approached in different proposals from several parties to the Montreal Protocol since 2009 (or an evolution of the Montreal Protocol).

In summary, the proposal as written at the date of the release of this report:

- Maintains the provisions of Regulation (EC) no. 842/2006, in particular the prevention of emissions, leak tightness control, requires the implementation of leak detection systems, record keeping, labeling, refrigerant recovery, while being more restrictive, especially for installations using high-GWP HCFCs since thresholds are now defined according to levels of charge in CO₂ equivalent (for example, R-404A installations are now concerned by quarterly leak tightness control from a charge of 128 kg)
- Extends certain containment measures to trucks (> 3.5 t) and refrigerated trailers
- Requires implicitly the implementation of training and certification programs by member states, while including the need that people handling fluorinated greenhouse gases be also trained to new technologies and the handling of new refrigerants.
- Introduces **quantitative limits to volumes of HFCs placed on the market within the European Union** by a gradual reduction over the period from 2016 to 2030, after a frost in 2015. These volumes, expressed in tonnes equivalent CO₂, are calculated on the basis of the reference volume corresponding to the annual average of total quantities produced and imported within the European Union over the period from 2008 to 2011. This reference volume is based on the declared³ quantities of refrigerants in bulk, and does not take into

³ <http://www.eea.europa.eu/publications/fluorinated-greenhouse-gases-2012>

account pre-charged equipment. Total quantities that can be placed on the market in 2016 and 2017 shall not be greater than 93% of this reference volume to reach **21% in 2030**, which is a reduction of 79%. Each producer or importer of HFCs (whose production exceeds 1000 t CO₂ eq. per year) will be allocated a **Quota** by the Commission, taking into account:

- Its own reference quantity from 2008 to 2011
- The percentage allowed for the current year
- A factor of 0.95 in order to allocate a quota to enterprises having no production or importation on the reference period

Quotas will be reviewed every three years (notification in the register of quotas) based on annual declarations by producers and importers reported to the Commission.

These measures are reinforced

➤ **By measures forbidding to place on the market (Annex III):**

- ✓ Domestic refrigeration charged with **HFCs having GWP higher than 150**, as of January 1st, 2015
- ✓ **Hermetic commercial refrigeration equipments** (refrigerators and freezers) charged with **HFCs having GWP higher than 2500**, as of January 1st, 2020 and **GWP higher than 150** as of January 1st, 2020
- ✓ **Movable room air conditioner appliances** charged with HFCs having GWP higher than 150 as of January 1st, 2020
- ✓ fire-protection systems and fire extinguishers charged with **HFC-23** as of January 1st, 2015.

This list may be amended by the Commission to include other equipments using HFCs with GWP higher than 150 (Article 9.3). Exemptions are possible for equipments for which it has been proven that total emissions throughout the life cycle were lower than those of similar equipment not containing HFCs and that meets the same ecodesign requirements.

➤ **And by measures and restrictions on use:**

With the prohibition of charging refrigeration equipments with HFC having a GWP above 2500 as of January 1st, 2020 if their charge is greater than 40 t CO₂ eq. (i.e. greater than 10.8 kg of R-404A, or 29.2 kg of HFC-134a).

HFCs concerned by these measures are listed in Annex 1 (primary fluids) and exclude unsaturated HFCs (R-1234yf and R1234ze are included in Annex II that relates to fluids included in the reporting in addition to that of Annex I). HFC-HFO blends will be concerned by prohibition and limitation measures since they contain HFCs listed in Annex I.

For GWPs, two references are given in Annex: the 4th Assessment Report of IPCC for HFCs and the 2010 Assessment Report by the Group of Scientific evaluation of the Montreal Protocol, for unsaturated HFCs. Whereas, the update of Regulation 842/2006 referred to GWPs given in the 4th Assessment Report (see Annex 7 for differences).

3.2.2 Regulation applicable to Explosive ATmospheres (ATEX) / Directive 94/9/EC and 99/92/EC

The Directive 94/9/EC concerns equipment manufacturers who must determine if their equipment must be subject to the Directive requirements.

The Directive 99/92/EC states that from June 2003 all new equipment acquired by a user shall comply with this Directive. For other equipment, users had 3 years to assess the security level EX. This directive was transposed into French law by Articles R. 4216-31 and R. 4227-42 to R. 4227-54 of the Labor Code.

Two orders of July 8th, 2003 supplement these articles transposing the Annexes to the Directive and specifying:

- The definition of places where explosive atmospheres may form
- The requirements for improving the safety of workers exposed to explosion hazards
- Criteria for selection of protection systems
- Signaling

A third order of July 28th, 2003 establishes the conditions for installation of electrical equipment in places where explosive atmospheres may occur.

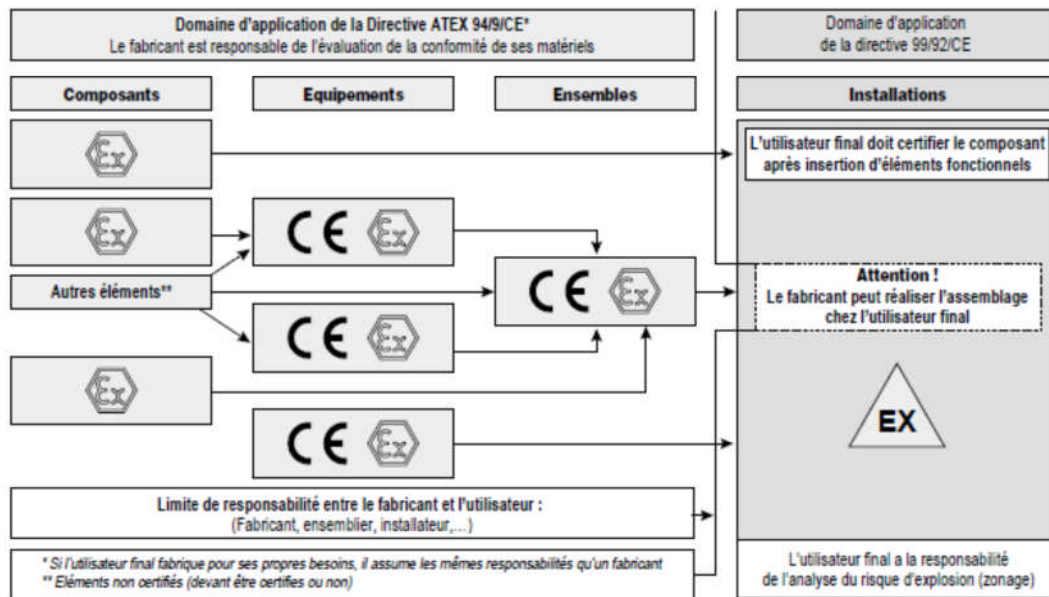

Figure 3.1 Respective application sectors of the two directives (LCIE pocket guide)

ATEX zoning is the responsibility of the user.

Table 3.1 specifies the explosive atmosphere zones. To be simple, the only two options for refrigeration or air conditioning systems (or any system) is to be out of area (so unnumbered) or zone 2, where an explosive atmosphere may be from a malfunctioning, typically rupture of a refrigerant piping or sufficient leakage to create such an atmosphere.

Table 3.1 Zones defined by the regulation

Explosive atmosphere	Gas/vapor zone	Particle zone
Permanent	0	20
Occasional in normal operation	1	21
Accidental in case of malfunction	2	22

One must keep in mind that the ATEX Directive is intended first for industrial units such as refineries, oil rigs, coal mines, grain silos, biogas units, etc ... which are high-risk installations because of the massive presence of combustible or explosive materials. The methodology is of course quite adequate for refrigeration systems containing flammable fluids. What is differentiating is in fact that equipment containing flammable fluids are in public buildings and residential dwellings without users or the public more generally, be aware of the risks and preventive measures.

Careful reading of both ATEX Directives indicates that IN ALL CASES it is the user who is ultimately responsible for the safety of equipment. This is in contradiction with the history itself of the introduction of flammable refrigerants, which have been introduced out of the ATEX Directive and according to EN 378 and IEC EN 60335-2-40, EN 60335-2-24 standards.

In fact, if referring to the last twenty-year experience for domestic refrigerators, key measures can be summarized as follows:

- Restriction of the charge to 150 g to limit consequences of a possible fire (in fact the charge is much lower for most of domestic refrigerators (from 20 to 70 g)
- Redesign of evaporators integrated in plastic walls and therefore not likely to be damaged by “knife” defrosting
- Containment of electrical components that may produce sparks

What is relatively new is the on-going extension of stand-alone display cases that operate with flammable refrigerants in spaces open to the public, namely supermarkets, and the availability of chillers running with propane (R-290) with charge going up to more than 50 kg.

When using flammable refrigerants, electrical components have to be ATEX. The general design of the equipment for the mechanical part can be a voluntary certification IECEx, which consists in obtaining a certificate of conformity to Directive 94/9/EC and that this certification mode is used only by companies whose equipment works in industrial ATEX zones.

For manufacturers of refrigeration equipment using refrigerants

- Very moderately flammable 2L (R-1234yf or R-1234ze or HFC-32 or R-717)
- Or moderately flammable (HFC-152a)
- Or flammable (R-290 ou R-600a)

The ATEX Directive 94/9/EC does not provide indication including those different classes, which are currently recognized for 2 and 3 by EN378 standard and 2L, 2 and 3 by Ashrae 34 standard. More generally, there is no harmonization yet between the ATEX Directive and EN378 standard. However, refrigeration equipment containing a refrigerant capable to create an explosive atmosphere falls within the ATEX Directive which, in fact, is not applied except by installing ATEX certified electrical components.

Manufacturers of refrigeration materials using flammable refrigerants apply and recommend “good practices” that can be found in a document such as the “Guide to Flammable Refrigerants – October 2012” by the BRA (British Refrigeration Association). These good practices analyze:

- Leakage risks
- The distribution of these leaks in the immediate surroundings and creation in a given volume of a potentially explosive atmosphere
- The presence or absence of ignition sources and, if such sources exist, hinder them (put them out of zone 2) or contain them
- Dilution by ventilation is a strategy for security that involves a concentration measurement in the control volume

3.2.3 Regulations applicable to Equipments under Pressure (PED)

Reference documents

- Directive 97/23/EC “Pressure Equipment Directive”
- Decree of March 15, 2000 related to the operation of equipments under pressure (modified by decrees of October 13th, 2000, March 30th, 2005 and January 31, 2011)
- CTP (professional technical notebook) N° 1 to 3

General description

Equipments for refrigeration production are equipments operating under pressure. To be placed on the market, they have to comply with the European Directive 97/23/EC of May 29, 1997 transposed into French law by Decree 99-1046 of December 13, 1999. Indeed, Directive 97/23/EC (PED) concerns all equipments of which the maximum allowable pressure is greater than 0.5 bar. It covers all elements of a system (vessel, piping, safety devices).

Under operation, some of these equipments are subject to the Decree of March 15th, 2000. This Decree provides for periodic pressure tests, often impossible to achieve on refrigeration equipment in operation. Once in service, these tests would require a complete emptying of the system and shut down.

For refrigeration and air conditioning, professional technical specifications (CTP1, CTP2, and CTP3) have been elaborated taking into account such a situation to exempt holders of these tests: internal audit, equipment opening and test during requalification.

Compliance of new facilities

As defined by the directive, pressure equipment includes the part under proper pressure, that is to say, the vessels, as well as the other parts of the system (piping, safety accessories and pressure accessories). To comply when placed on the market, the new equipment shall have the EC marking. The Directive applies to the design and manufacturing of equipment and establishes essential requirements to meet in terms of safety. It also defines four classes of equipments based on the maximum allowable pressure and volume for vessels or heat exchangers (Figure 3.2). Other criteria apply to the pipes according to the service pressure and the nominal diameter.

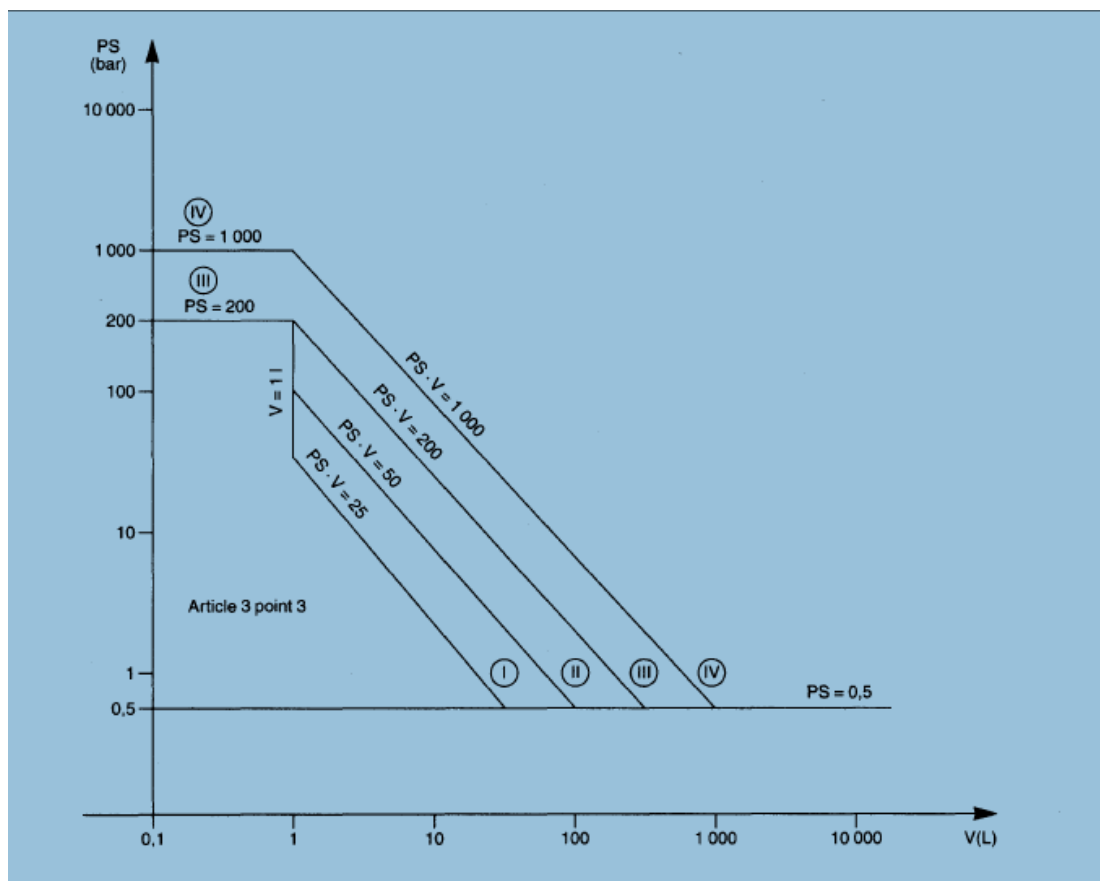

Figure 3.2 Classes of equipments as a function of the maximum allowable pressure and volume

Depending on the class of equipment and thus of the risk incurred, the Directive foresees a number of conformity assessment methods, ranging from simple declaration of conformity by the manufacturer, to evaluations of the equipment or the quality system of the manufacturer by a certifying third party. These third-party assessments are carried out by competent bodies designated by the Member States and notified to Brussels.

Control of equipment in operation

The decree of March 15th, 2000 imposes a periodic **inspection** and periodic requalification, consisting of a tour and test of pressure parts of the vessels. These tests are supplemented by an inspection of pressure and safety accessories, piping and supports. These provisions are not harmonized in Europe

and are ruled by national law. The provisions of this Decree apply to both "old regime" pressure equipment and those designed under the "new regime", designed and manufactured according to the provisions of Decree 99-1046 of December 13th 1999 (PED 97/23/EC).

The operator shall maintain a record on pressure equipment operating on the site. This file comprises:

- An updated list of equipment covered by the Decree of 03/15/2000,
- A description dossier of each of these equipments (in particular the statement of compliance on the equipment)
- A holding file established for each of these equipments subject to reporting commissioning, that is to say, the control plan and documents of the periodic inspection and periodic requalification.

The operator must submit a declaration of commissioning to the Prefecture for its equipment, perform periodic inspections for each of its facilities and periodic requalification for some of its equipment.

The periodic inspection

- Takes place each 40 months maximum for equipments submitted to CTP1, and annual for equipments complying with CTPs 2 and 3
- Is realized under the responsibility of the operator, by a competent person designated for this purpose, able to recognize defects that may be encountered and to assess the severity. It will be a competent person for facilities subject to CTP1 and a person entitled to the facilities subject to CTPs 2 and 3
- Check the condition of the pressure equipment to allow it to be kept in service with a level of security consistent with foreseeable operating conditions
- involves analysis of the record of the installation and operation, the external visual inspection, verification of heat exchangers, checking safety equipment, checking the leak tightness, checking the absence of non-condensable, recording of inspection results

Pipings are subject to inspections of which the nature and periodicity are defined in a control schedule established by the operator during the year of their commissioning.

Periodic requalification takes place each five years for installations operating with ammonia and every ten years for installations operating with HFCs. Periodic requalifications are performed by an expert from a recognized body or a recognized inspection service authorized to that effect.

Periodic requalification includes document verification (descriptive file + operating folder) and re-calibration or replacement of safety valves. It concludes with a statement accompanied by a report and bears the stamp of the State affixed by the authorized body.

3.2.4 Regulations applicable to Classified Installations for Environmental Protection (ICPE)

Refrigeration installations can also be regulated by texts related to classified installations for environmental protection; they constitute articles in Book V Title 1st of the Environmental Code (L511-1).

Are subject to the provisions of this regulation, factories, workshops, warehouses, construction sites, and in general, facilities operated or owned by any moral or legal person, public or private, which can present dangers or disadvantages for either the convenience of the neighborhood or to the health, safety, public health, or for agriculture or for the protection of nature, environment and landscape, or for the rational use of energy, or for the conservation of sites and monuments and archaeological heritage. Installations classified for the protection of the environment are managed items.

Criteria for refrigeration systems are intrinsically the nature and amount of refrigerant contained in the system, the level of effective pressure and power consumption, and the presence of cooling towers. One can distinguish the following risks:

- The intrinsic toxicity of refrigerants for the safety of persons or the environment
- Risks related to the pressure
- For health, risks of Legionella

Depending on their level of danger, facilities are subject to declaration, registration or authorization.

Safety of persons: Section 1136B: Ammonia use

Concerning the use of ammonia, facilities are subject to declaration with periodic inspection when they involve more than 150 kg of ammonia and less than 1.5 t and to authorization when the amount of ammonia is between 1.5 and 200 t, and to authorization with servitude of public utility beyond (section 1136B).

When an installation falls within the scope of section 1136, the Order of November 19th, 2009 is applicable; facilities are therefore subject to periodic inspection every 5 years, as described in Annex IV of the Order. These inspections involve verification of the implementation of the obligations, from a documentary and effective point of view, concerning criteria of installation, safety, accessibility, cleanliness, instructions for operating and signaling, and risks inherent to the use of ammonia. In particular, for leak detection, the operator lists its detectors with their functionality and determines maintenance designed to maintain their effectiveness over time operations. Gas detectors are set up in areas likely to be affected by the ammonia leak, in particular machinery rooms, as well as technical areas.

Parts of the installation that, due to qualitative and quantitative characteristics of the materials used, stored, used or produced, may be the cause of a disaster are equipped with detection systems with different levels of sensitivity adapted to situations. The operator sets at least two safety thresholds as follows:

- Crossing the first threshold (500 ppm in areas where the operating staff is always present, or 2000 ppm otherwise) resulting in an audible or visual alarm and startup of additional ventilation in agreement with standards in force
- Crossing the second threshold (i.e. 1000 ppm in areas where the operating staff is always present, or 4000 ppm otherwise) results in addition to the foregoing, the securing of facilities, an alarm audible at all points of the facility and, if necessary, a remote transmission to a technically competent person.

Figure 3.3, Table 3.2 and 3.3 summarize the French ammonia regulation.

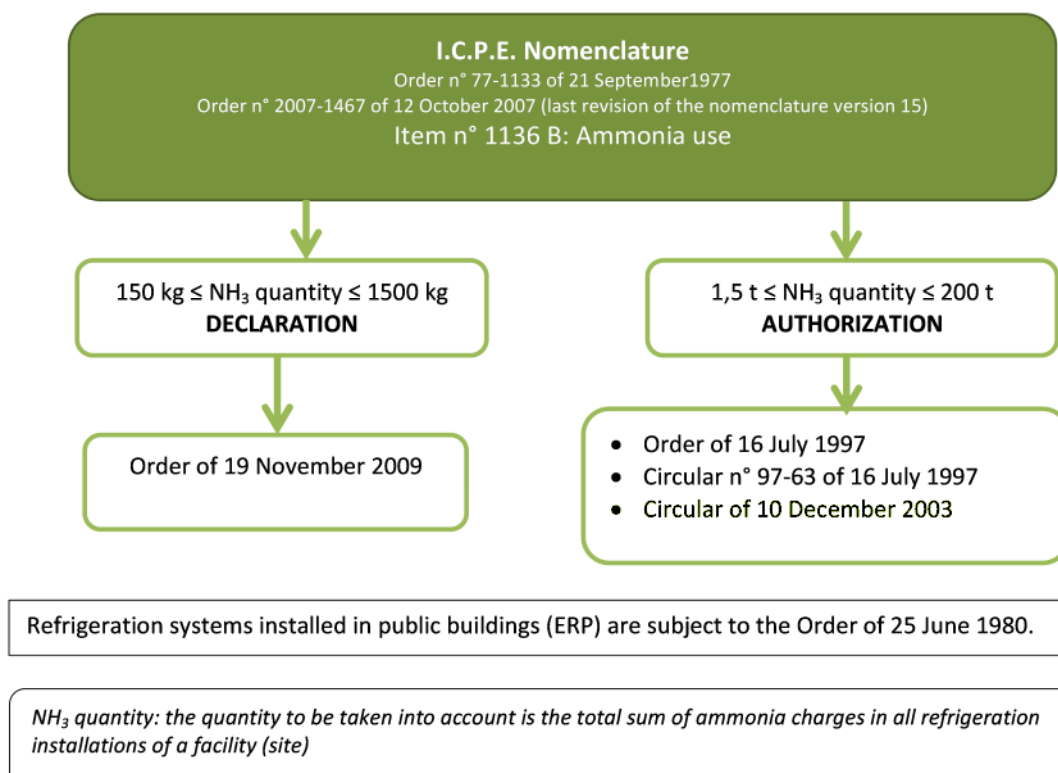

Figure 3.3 Scope of the ammonia regulation (NH₃ or R-717).

Table 3.2 Who can perform a control or verification of installations?

DECLARATION 150 kg ≤ NH ₃ quantity ≤ 1500 kg	AUTHORIZATION 1.5 t ≤ NH ₃ quantity ≤ 200 t
<p>List of organizations agreed to date to perform compliance controls of installations</p> <ul style="list-style-type: none"> ▪ APAVE Alsacienne ▪ APAVE Parisienne ▪ CETE APAVE Sud Europe ▪ CETE APAVE Nord Ouest ▪ Bureau Veritas ▪ AXE ▪ QUALICONSULT ▪ ECOPASS <p>The detail of compliance points to control is mentioned in Annex III of the Order of November 19th, 2009. Note: this compliance control by an approved organization does not affect in-house checks of installations.</p>	<p>Order of July 19th, 1997 Art. 9 « This verification has to be performed by a competent person or a company nominated by the operator with the approval of the inspection of classified installations »</p> <p>Important remarks</p> <ul style="list-style-type: none"> ✓ It is the duty of the operator of the facility to submit to the local authorities (DRIRE, DREALs or DSV) the choice of the person or company competent to carry out these checks. ✓ The operator of the facility is the contact authorities and not its suppliers or subcontractors. ✓ There is no approval or authorization issued by the authorities so that refrigeration companies can achieve these checks.

Table 3.3 Regulation and regulatory controls of installations operating with NH₃.

Not classified I.C.P.E. NH ₃ quantity < 150 kg	DECLARATION 150 kg ≤ NH ₃ quantity ≤ 1500 kg	AUTHORIZATION 1.5 t ≤ NH ₃ quantity ≤ 200 t
<p>Regulatory control is not mandatory.</p> <p>For refrigeration systems installed in public buildings, an annual technical check is mandatory (article CH 58 of the Order of June 25th, 1980).</p> <p>Technical checks have to be performed by approved organizations (article GE 7 à GE 9 of the Order of June 25th, 1980)</p>	<p>Modification of the Order of February 23rd, 1998, control of the compliance of installation by an approved organization:</p> <ul style="list-style-type: none"> • 6 months after the first commissioning • Periodically, maximum every 5 years (10 years max. for sites certified ISO 14001 or EMAS) • For installations in service priori December 31st, 2008: date extended to June 30th, 2009. 	<p>Order of July 16th, 1997 Art. 9: the installation has to be controlled in the following cases: First commissioning Extended shutdown of the refrigeration system Significant modification of the installation Maintenance requiring a long shutdown Annual inspection. Audit carried out by a competent person or company designated by the operator with the approval of the inspection of classified installations.</p> <p>Circular of December 10th, 2003 Reminder of the operator obligations on the verification of systems with a summary table of controls to achieve.</p>

Risk for the environment: Section 1185 2a: use of fluorinated greenhouse gases

Concerning the use of fluorinated refrigerants subject to regulation 842/2006/EC of substances depleting the ozone layer, regulation 1005/2009, installations including equipments charged with more than 2 kg and of which the cumulated refrigerant charge is greater or equal to 300 kg are submitted to declaration with periodic control (Section 1185 2a).

Section 2920: compression installations

Are also subject to authorization, compression installations operating at effective pressures higher than 10⁵ Pa and compressing or using flammable or toxic, the input power being higher than 10 MW (Section 2920).

Health risk: Section 2921 (under revision): cooling by water dispersion in an air flow

Concerning cooling towers, Section 2921 indicates that a declaration is necessary when cooling installations by water dispersion in an air flow are of closed type or in reverse case, when the heating capacity released is less than 2 MW, and authorization beyond.

3.2.5 Regulations applicable to public buildings (ERP)

Public buildings are subject to additional safety rules. Thus the Order of June 25th, 1980 defines the general provisions of safety rules against fire and panic risks in public buildings. This safety regulation sets very general rules applicable to buildings such as the fire resistance of the building or interior equipment. Chapter 5, entitled "Heating, ventilation, air conditioning refrigeration, air conditioning, and domestic hot water system", is the only one to address the issue of air conditioning or air treatment. In Paragraph CH 35 applying to comfort ventilation and thus air-conditioning, it includes requirements on refrigerants. The use of A1 and A2 refrigerants is authorized under certain conditions and group A3 refrigerants are forbidden. Groups of fluids considered in this paragraph referred to Standard 378-1 of 2011. It is important to mention that Chapter 5 of this Order and Article CH35 use improperly the term of refrigeration for applications under air conditioning. This has also led the safety commission, in 2008, to extend requirements applicable to cooling comfort to process equipment (display cases containing R-290) so limiting the refrigerant charge to 1.5 kg, limit

defined by Standard 378-1 (2011). Faced to this French ban to install this equipment in a public building, the manufacturer of the equipment brought an action to SOLVIT. SOLVIT is a network to solve problems online, proposed by the European Commission in the event of national regulations generate technical or administrative barriers to trade within the union: EU Member States cooperate to solve, pragmatically, problems caused by the misapplication of internal Market law by public authorities. SOLVIT has seized the Safety Committee in April 2008. The latter waived the above mentioned ambiguity about the term refrigeration. Members of the subcommittee "gas heating of large kitchens" recalled that Articles CH of the safety regulations do not apply to refrigeration installations for food processing. Furthermore, the type M imposes no specific provisions on this subject. Accordingly, there is no objection to the use of refrigeration systems charged with hydrocarbons in a public building. The application of Article CH35, to justify an unfavorable opinion, does not seem relevant here since it is in a chapter on ventilation (there may have been a confusion due to the presence of the word "cooling")

Although there is an M42 article, which has restricted the amount of liquefied hydrocarbons in commercial areas, this limit is at a level such that hundreds of devices similar to those concerned with the recourse (retail display cases) would be needed to reach it.

To conclude, the sub-commission recalls that it would be entitled to require safety distances between these freezers to avoid propagation of a fire and that it is essential that the hazard pictogram related to propane be clearly visible on the outside of the freezer to prevent the presence of a particular risk if firefighters were to intervene in case of fire on or near these equipments.

Still many users keep in mind that regulation for public buildings precludes the use of R-290 as refrigerant while it is not. However, the rules applied by the safety committees are sufficiently vague to allow local interpretations mediate obligations relevant to operators.

There remains however that the fire risk is recognized and it induces a threshold of psychological load at which an operator refuse this technical solution.

3.3 STANDARDS APPLICABLE TO REFRIGERATION AND AIR-CONDITIONING INSTALLATIONS

3.3.1 Series of EN 378 Standard – Refrigeration systems and heat pumps – Safety and environmental requirements

Standard EN-378 includes 4 parts:

Part 1 – Basic requirements, definitions, classification and choice criteria

Part 2 - Design, construction, tests, labeling, and documentation

Part 3 - Installation in situ and protection of persons

Part 4 - Operation, maintenance, repair, and recovery

The standard structures:

- Three types of occupancies (A, B, and C) (cf. Table 3.4)
- Different structures of equipments (direct expansion and various indirect expansion systems)
- A classification of safe or toxic or flammable refrigerants (cf. Table 3.5).

Based on these three structurations recommendations are defined on charge limits of refrigerant referred to the room where the system is installed.

Table 3.4 Occupancy categories

Category	Characteristics
A: general occupancy	Buildings where people can sleep, with restricted mobility, uncontrolled number people, without possible knowledge of safety measures
B: monitored occupation	Buildings or rooms where a limited number of persons can get together, some being informed of general safety rules
C: authorized access only	Rooms or buildings where only people informed on safety measures can access.

Table 3.5 Safety classes of refrigerants.

	A: Non toxic No effect for chronic exposure (40 h for a concentration ≥ 400 ppm)	B: Toxic Effect for a chronic exposure (40 h for a concentration < 400 ppm: toxic)
1: Non flammable	A1 (HFC-134a)	B1 (R-123)
2: Moderately flammable	A2 (HFC-152a)	B2 (ammonia)
3: Flammable	A3 (R-600a)	B3

Based on the safety class, a Refrigerant Concentration Limit is calculated by taking the most restrictive criterion either for toxicity or for flammability. Table E1 of Part 1 Annex E gives Refrigerant Concentration Limits expressed in kg/m³ and Tables C give the rules for refrigerant charge calculation depending on the building category. For an A1 refrigerant, it comes Table 3.6.

Table 3.6 Calculation of the charge for an A1 fluid.

A: general occupancy	Max charge = Refrigerant Concentration Limit x room volume
B: monitored occupation	Basement or floors without adequate safety exit as Category A Otherwise no limit
C: authorized access only	Basement or floors without adequate safety exit as Category A Otherwise no limit

For an A3 fluid, it comes Table 3.7.

Table 3.7 Calculation of the charge for an A3 fluid.

	Direct expansion system	Indirect expansion system
A: general occupancy	<i>Air conditioning:</i> $M_{max} = 2.5 \times LFL^{5/4} \times h_0 \times A^{1/2}$ With LFL: lower flammability limit H ₀ : height of the equipment in the room A: room surface <i>Refrigeration systems:</i> Charge max = RCL x room volume With maximum charge of 1.5 kg	Idem direct expansion system
B: monitored occupation	Basement or floors without adequate safety exit as Category A Otherwise no limit	Idem air conditioning 1kg in the basement Up to 25 kg at the surface
C: authorized access only	Basement or floors without adequate safety exit as Category A Otherwise no limit	Idem air conditioning 1 kg in the basement No limit at the surface

The standard defines in its Part 2, all design and test precautions and is linked to Standard EN 60079-15:2005 "Electric material for explosive atmosphere", otherwise no explicit relation to Directive ATEX 94/9/EC. So that the design of refrigeration equipment according to EN 378 "escapes" to complete ATEX approach and in particular vis-à-vis the user.

3.3.2 Standard ASHRAE 34 - Designation and safety classification of refrigerants

The ASHRAE Standard Committee is the only place in the world where physical characteristics, toxicity and flammability of refrigerants are reported. The examination is carried out in parallel in the sub-committees "nomenclature", "toxicity", and "flammability". These subcommittees report to the Committee which validates the work, thereby introducing new fluids or new mixtures with R-prefix for refrigerant.

Preliminary studies are costly and time consuming especially for toxicity. Strategically, ISO 817 Committee should have replaced the ASHRAE 34 Committee but it is undeniable that the ISO organization has not yet demonstrated an ability to move faster than the ASHRAE 34 Committee. So much so that the introduction of the burning velocity (BV), which was made in ISO 817 in 2003, was actually introduced in 2010 ASHRAE 34 (see Figure 3.4) whereas ISO 817-5 is still awaiting approval.

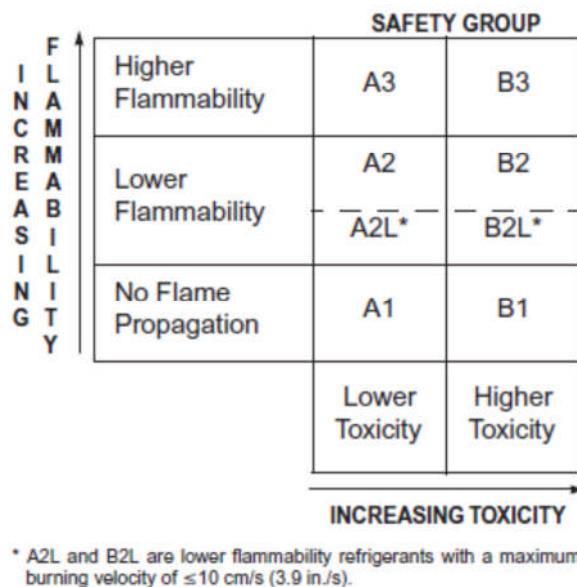

Figure 3.4 Safety group of refrigerants according to ASHRAE 34 -2010 Standard.

The classification of fluids of EN 378 depends of the ASHRAE committee works, for the safety classification as well as for the nomenclature; hence the update of EN-378 is still several years behind that of ASHARE 34 which proceeds by addenda.

ASHRAE 15 is the equivalent of EN 378, which is organized in the same way: category of occupancy, types of systems (direct or indirect) and refrigerant class. However, the calculation rules differ, but restrictions on the use of refrigerants 2 and 3 are lower than in previous versions (ASHRAE 15-2010).

3.3.3 Industry standards applicable to installations or equipments

Complementary to the above mentioned regulations, State agreements or standards exist by type of application, of which compliance is required either by the state of the art or by industry standard.

In the sector of refrigerated transport, France has signed an international agreement within the UN framework for the recognition of technical means used in international transport for perishable foodstuffs (ATP agreement). To implement this agreement, the French government, as is the case for 58 other signatory countries, has established a national regulation requiring technical compliance

of transport units and extended to national transport. This regulation aims at the reinforcement of food hygiene and defines minimum characteristics of mobile refrigeration systems to enable compliance with the cold chain. Although this regulation does not impede technological developments and innovation, it involves mandatory requirements in terms of cooling capacity in the particular context of road or rail transport.

A similar agreement, for transportation of hazardous goods, is applied in the same way and can, for certain technical solutions, provide a regulatory slowdown for cold storage solutions that can be treated as hazardous goods.

The bulk milk tanks are also subject to additional requirements in terms of cooling speed of the milk in order to keep its organoleptic characteristics and the absence of health risk. Standard and voluntary certification (NF, Key brand CEN) provides a system for the recognition of the conformity of products which, although voluntary, underlies the applicable regulation.

3.4 ECO-DESIGN DIRECTIVE 2009/125/EC

Refrigeration systems and heat pumps are “energy-related products” as defined in the European Directive 2009/125/EC [DIR09] giving recommendations for the eco-design of this type of product. This directive is complemented by the European regulation 206/2012 [REG12] dated March 2012 that regulates the eco-design of air-conditioning equipments.

This regulation and this directive, associated to methodological documents (MeeRp 2011), allow the definition of positive and negative environmental impacts of refrigeration equipments and heat pumps.

Relevant indicators of environmental impacts are as follows:

- The mass of waste
- The total primary energy consumption (including manufacturing of system components)
- Emissions of acidifying gases
- Reduction of abiotic resources
- Emissions of greenhouse gases
- Ozone depleting substances
- Emissions of photochemical oxidants.

Regulation 206/2012 defines eco-design requirements of air-conditioning systems by application of Directive 2009/125/EC and a regulation is under preparation for small commercial refrigeration equipments.

The major requirement of application regulations 206/2012 (reversible air conditioners < 12 kW), 813/2013 (air-to-water and water-to-water heat pumps for heating of buildings) and 814/2013 (heat pump for domestic hot water) concerns energy efficiency.

The method to assess impacts is the comparative method where a technology is compared to competitive technologies fulfilling the same functions and providing same services. The method implies to describe the life cycle of the product, to decompose the product in materials (mass balance), to analyze their energy content (grey energy), to analyze their recyclability, and to define for refrigeration and air-conditioning equipments, and heat pumps, impacts of the usage period, which is the dominant phase with the associated energy consumption. Refrigerant emissions constitute usually the second major impact because of their ODP for the remaining HCFCs and their GWP for HFCs in use.

The method also includes the analysis of society impacts on the health and the safety of users as well as operators for manufacturing and maintenance.

Essential literature

DIR 09 Directive 2009/125/EC of the European Parliament and of the Council of October 21st, 2009 establishing a framework for the setting of ecodesign requirements for energy-related products.

MeeRp 2011. Methodology for Ecodesign of Energy-related Products. MEErP 2011. Final Report. Part 2 : Environmental policies and data. Report for the European Commission, DG Enterprise and Industry. Contract SI2.581529.

REG 12 Commission Regulation (EU) No 206/2012 of 6 March 2012 implementing Directive 2009/125/EC of the European Parliament and of the Council with regard to ecodesign requirements for air conditioners and comfort fans.

4. REFRIGERANTS OF VAPOR COMPRESSION SYSTEMS

4.1 INTRODUCTION

The refrigerant bank (CFCs, HCFCs, HFCs, ammonia, HC, and CO₂) is evaluated at the global level at 3.5 million tonnes with average annual emissions of 17%, in the range of 600,000 metric tonnes, which gives emissions in equivalent CO₂ of 2.5 billion of metric tonnes (data ARMINES CEP and EReE). This corresponds to the fact that vapor compression equipments include approximately 2.7 billion of equipments including 1.5 billion of domestic refrigerators.

Table 4-1 Estimation of the worldwide installed base of equipments.

Sector	Lifetime (years)	Estimated worldwide installed base
Domestic refrigeration	15	1,500,000,000
Commercial refrigeration Condensing units	12	35,000,000
Commercial refrigeration Stand-alone	7	55,000,000
Commercial refrigeration Centralized systems	10	300,000
Industry equipment (Food processing and others) not including chillers	30	150,000
Refrigerated transport (road)	10	2,000,000
Refrigerated containers	10	1,200,000
Air-to-air conditioners	10	600,000,000
Heat pumps (including water heaters)	12	7,000,000
Centrifugal chillers	30	170,000
Volumetric chillers	20	2,600,000
Mobile air-conditioning	10	500,000,000
Total		2,700,000,000

According to sectors, refrigerant changes result in equipment renewal a little faster due to the phase out of a category of molecule. Equipment operating with an old refrigerant retrofitted to a new refrigerant whose thermodynamic and usage properties are very close (including safety) to the former refrigerant may operate during their usual average lifetime.

4.2 ORIGIN OF THE CHOICE OF CFCs AND HCFCs AS REFRIGERANTS

CFC-12 was invented around 1930, by Midgley to replace propane and SO₂ in domestic refrigerators to make available a refrigerant neither flammable nor toxic. This refrigerant replaced progressively propane, SO₂, and CO₂ in different refrigeration applications.

HCFC-22 was invented in the 50's to make available a molecule having a volumetric capacity higher than that of CFC-12 and, in fact, close to that of ammonia. Finally, different molecules, such as

CFC-11, have been invented for other uses than refrigeration applications as solvents or blowing agents in insulation foams.

4.3 FROM CHLOROFLUOROCARBONS (CFCs) TO HYDROFLUOROCARBONS (HFCs)

The ozone hole

As soon as 1970, as a result of studies performed by NOAA in the United States to analyze the potential disruptions caused by supersonic aircraft Concorde in the stratosphere, significant contents of CFC-11 have been identified. In the late 80s, the ozone hole over Antarctica was discovered; the analysis of ten years has shown the role of catalytic destruction of ozone (O₃) by the chlorine monoxide (ClO), which comes from the CFC destruction by “hard” UV met at these altitudes (between 10 and 50 km). The hole found at the end of the austral winter is related to the lack of sun during a number of months, that prevents the creation of ozone and generates a very significant and verifiable ozone hole in this Antarctic zone, which is relatively isolated from the rest of the earth atmosphere, because of the Antarctic continent itself, contrary to the North Pole where this not a significant land mass.

The Montreal Protocol

These analyses performed progressively gave rise to some controversy, but the scientific and political consensus was reached at the Vienna conference in 1985. Then the Montreal Protocol (1987) established a global schedule to stop the production and commercialization of CFCs by January 1st, 1995 for developed countries and 10 years later for developing countries (known as the Article 5 of the Montreal Protocol). Then another calendar has been implemented to stop the production and commercialization of HCFCs, with December 2010 as the termination date for developed countries, Europe having banned their use as soon as year 2000. The schedule for the HCFC ban is under implementation in Article 5 countries, with a full stop in 2030 (except 2.5% for maintenance).

Decision XIX/6, of Parties to the protocol of September 2007, sets the reduction schedule presented in Table 4.2 for Article 5 countries, for their consumption level of 2013.

Table 4.2 Reduction schedule for the production and the commercialization of HCFCs of Article 5 countries.

Reduction	Date
-10%	2015/12/31
-35%	2020/12/31
-67.5%	2025/12/31
Recharge in maintenance	2.5% for 2030 to 2040

For main CFCs (chloro-fluoro-carbons), Table 4.3 gives historical application sectors of these refrigerants.

Table 4.3 Application sectors of CFCs

Commercialized CFCs	Application sectors
CFC-12	Domestic refrigeration, small commercial refrigeration, refrigerated transports, mobile air conditioning, centrifugal chillers
CFC-11	Centrifugal chillers
CFC-114	Industrial heat pumps, submarines
R-502 (HCFC-22/115 48.8/51.2)	Commercial

Table 4.4 gives application sectors for main HCFCs (Hydro-chloro-fluoro-carbons). For both types of molecules, niche applications are not indicated.

Table 4.4 Application sectors of HCFCs

Commercialized HCFCs	Application sectors
HCFC-22	Air-air conditioning, volumetric chillers, commercial refrigeration, industrial refrigeration, refrigerated transports
HCFC-142b	Industrial heat pumps

From the Montreal Protocol application, HFCs have replaced CFCs as well as HCFCs while being in competition with hydrocarbons, ammonia, and CO₂. As it is known, HFCs became dominant from 1992 up to now and their GWPs is the cause of limitations, and then of prohibitions of use to come.

Table 4.5 specifies which HFC substitute for prohibited molecules production. Again, we do not go into details of intermediate blends that have replaced CFCs and contained HCFCs.

Table 4.5 Main HFCs having replaced CFCs and HCFCs.

Molecules prohibited by the Montreal Protocol	Replacement HFCs
CFC-12	HFC-134a
R-502 (HCFC-22/115 48.8/51.2)	R-404A (HFC-125/143a/134a - 44/52/4) R-507AA (HFC-125/143a - 50/50)
HCFC-22	R-404A (HFC-125/143a/134a - 44/52/4) R-410A (HFC-32/125 - 50/50) R-407C (HFC-32/125/134a - 23/25/52)

We voluntarily remained on the most used refrigerants that represent 90% of the market, which indicates that the multiplicity of proposed options at one time will simplify, for reasons of standardization associated with the mass production of most refrigeration and air-conditioning equipments. Note: In the remainder of this chapter, refrigerants are presented in the form of factsheets inspired by tables of the TEAP report 2013.

HCFC-22	
Main characteristics	ODP: 0.05 GWP: 1790 T _{critical} = 96°C Normal boiling point: -40.8°C
Marketing extent	The most used refrigerant in the world, for commercial refrigeration, industrial processes and mainly air-to-air conditioning systems. Its refrigerant bank is estimated to 1.6 million metric tonnes at the global level.
Energy efficiency (taking into account ambience conditions)	The energy efficiency of this refrigerant became a reference for the validation of its substitutes: R-404A in commercial and industrial refrigeration and R-407C and R-410A in air conditioning. The volumetric refrigerating capacity of R-407C is identical to that of HCFC-22, that of R-404A is 10% higher, that of R-410A, 20%. COPs of their successors are in the same range as that of HCFC-22.
Costs, profitability (referred to a reference)	The price of this refrigerant varies depending on the country. Because of its end of production in developed countries, its price as a maintenance refrigerant can be locally high (from 30 to 50 €/kg) in the coming years. In Europe, HCFC-22 will be banned in maintenance as of January 1 st , 2015.
Barriers and restrictions	The barrier is the scheduled end of production.

HFC-134a	
Main characteristics	GWP: 1370 $T_{critical} = 101^{\circ}C$ Normal boiling point: $-26^{\circ}C$
Marketing extent	This refrigerant is the most used HFC because of its massive use in mobile air conditioning. Its bank in 2012 is evaluated at 1.2 million of tonnes at the global level.
Energy efficiency (taking into account ambience conditions)	HFC-134a is a reference for its replacement candidates for the different applications he was used and is still used, mainly domestic refrigeration, centrifugal and screw chillers, small commercial refrigeration and mobile air conditioning.
Costs, profitability (referred to a reference)	This refrigerant price is in the range of 12 to 15 €/kg. We can also say that from its initial production, in 1994, it has been already in "overproduction" and consequently a convenience price type rather quickly.
Barriers and restrictions (safety, energy efficiency, etc.)	The first barrier is that its use is not permitted in mobile air conditioning for new platforms since January 1 st 2011, even if the effective application started just during the second semester of 2013. This refrigerant is still widely used worldwide in the applications presented above. Its future is counted even though the date of end of production is not set yet

R-407C (HFC-32/125/134a - 23/25/52)	
Main characteristics	GWP: 1700 $T_{critical} = 86^{\circ}C$ Normal boiling point : $-43,6^{\circ}C$ R-407C has been designed to replace strictly HCFC-22 with the same volumetric capacity. By changing the expansion device and going from an alkyl-benzene oil used ofr HCFC-22 to POE oil adapted to HFC, the retrofit from HCFC-22 to R-407C is possible. Its main problem is the temperature glide during condensation and evaporation ($5^{\circ}C$) and its formulation change in case of leak.
Marketing extent	R-407C is used in small and medium capacity commercial refrigeration and in roof-top type systems; in particular during the intermediate period where compressors designed for HCFC-22 were more available than that designed for R-410A or R-404A. The bank, at the global level, is estimated at 90,000 metric tonnes.
Energy efficiency (taking into account ambience conditions)	The energy efficiency is similar to that of HCFC-22, even though adaptations have to be done. However, in low temperature refrigeration, frost appears quite quickly because the initial evaporation temperature is lower.
Costs, profitability (referred to a reference)	The price of this refrigerant is in the range of 18 to 20 €/kg. Its safety classification is A1.
Barriers and restrictions (safety, energy efficiency, etc.)	It will not be replaced immediately because of its GWP, but it will not be used on the long term and is replaced by R-404A on one side and R-410A on the other.

R-404A (HFC-125/143a/134a - 44/52/4)		R-404A GWP: 3700, $T_{critical} = 72^{\circ}C$ Normal boiling point: $-46.2^{\circ}C$	
R-507AA (HFC-125/143a- 50/50)		R-507AA GWP: 3800, $T_{critical} = 70.6^{\circ}C$ Normal boiling point: $-46.7^{\circ}C$	
Main characteristics	Those two refrigerants are very close and in fact R-404A is the answer of two refrigerant manufacturers to the patent of a third one on R-507AA. R-507AA is an azeotropic blend and therefore behaves as a pure substance; a priori it had a large advantage in the competition, but the sales force won and the market was dominated by R-404A. Those two refrigerants have been designed to replace R-502 and HCFC-22 in commercial and industrial refrigeration.		
Marketing extent	The R-404A bank is estimated, worldwide in 2012, at 250,000 tonnes and that of R-507AA at 33,000 t.		
Energy efficiency (taking into account ambience conditions)	Both refrigerants present energy efficiencies similar to that of HCFC-22 but lower than that of R-502, to which nobody refers any longer.		
Costs, profitability (referred to a reference)	The price of those refrigerants (from 15 to 20 €/kg) decreased in recent years, in relation with their predictable ban by the future European regulation.		
Barriers and restrictions (safety, energy efficiency, etc.)	Main barriers are to come; their commercialization will be prohibited in the future European regulation.		

R-410A (HFC-32 / 125 - 50/50)	
Main characteristics	GWP: 2100, $T_{critical} : 71.4^{\circ}C$ Normal boiling point: $-51.4^{\circ}C$ This refrigerant massively used in air-air conditioning for split and centralized systems, typical in the U.S., presents the great advantage of high volumetric capacity, and so can be used with compact scroll compressors. Its critical temperature is only of $71^{\circ}C$, which is not the most favorable for hot climates.
Marketing extent	The R-410A market increased rapidly but the U.S. maintained the use of HCFC-22 until the "last minute" (end of 2010) in air-air conditioning. It results an overall bank in the range of 80,000 tonnes in 2012.
Energy efficiency (taking into account ambience conditions)	The energy efficiency, in climatic conditions with condensation temperatures up to $40^{\circ}C$, is slightly higher than that obtained with HCFC-22. Beyond, especially from $55^{\circ}C$ of condensing temperature, energy efficiencies deteriorates.
Costs, profitability (referred to a reference)	The price of this refrigerant is in the range of 18 to 20 €/kg.
Barriers and restrictions (safety, energy efficiency, etc.)	R-410A has no replacement candidate identified yet and its GWP is a threshold for prohibited marketing molecules by the new European regulation.

4.4 THE REVIVAL OF REFRIGERANTS: HYDROCARBONS, AMMONIA, AND CO₂

This section presents briefly significant elements for each refrigerant and synthetic factsheets are introduced for each refrigerant or refrigerant family when more appropriate.

Hydrocarbons (HC)

From the introduction of HFC-134a is born, especially in Europe, a movement of mistrust towards HFCs aiming at the replacement of CFCs and HCFCs. The organization Green Peace, in particular, highlighted the replacement of CFC-12 by hydrocarbons. This movement brought, in a very few years, European leaders of domestic refrigeration (Bosch Siemens, AEG, Electrolux) in shifting progressively their production from HFC-134a to isobutane (R-600a). The isobutane charge being low (between 20 and 70 g) and the design of the evaporator being revisited, safety conditions have been considered (and still are) acceptable. The only notable incidents that have been reported concern incidents related to the charge at the factory.

In small commercial refrigeration, propane is used mainly for refrigerating capacities varying from 300 W to 5 kW. Systems also exist with charges varying from 50 g to 1.5 kg. The lowest the charge, the most significant the commercialization of these systems.

Also air-to-water heat pumps operate with propane and small air-conditioning systems so-called “movable”. Air-to-water heat pumps can have their thermodynamic system charged with R-290 installed outdoor the single house and the heat is transferred indoor by a water-glycol circuit.

Hydrocarbons (HCs)	
HC 600a isobutane	HC-600a GWP 4, $T_{critical} = 134.7^{\circ}C$ Normal boiling point: $-11.7^{\circ}C$
HC-290 Propane	HC-290 GWP 5, $T_{critical} = 96.7^{\circ}C$ Normal boiling point: $-42.1^{\circ}C$
HC-1270 Propylene	HC-1270 GWP 2, $T_{critical} = 91.1^{\circ}C$ Normal boiling point: $-47.6^{\circ}C$
Main characteristics	Hydrocarbons (HCs) include three major pure refrigerants, HC-290 (propane), HC-1270 (propylene), and HC-600a isobutane, and some refrigerant blends such as R-433A, R-433B, R-433C, R-441A, and R-443A, where some can contain HC-170 (ethane). Pure refrigerants and blends present a safety classification A3 (low toxicity, high flammability), their ODP is nil and their GWP varies from 1.8 to 5.5 (WMO, 2010). HCs have excellent transport and thermodynamic properties.
Marketing extent	Pure refrigerants (HC-600a and HC-290 mainly) have been used as early as 1992; blends such as R-436A and R-436B, have a low commercial development. Large scale commercialization of HCs is limited because of restrictive uses defined by safety standards (EN378 or ASHRAE 15) in occupied spaces.
Energy efficiency (taking into account ambient conditions)	Generally, the energy efficiency is proven good in most of conditions. In principle, they present thermophysical properties that lead to energy efficiency as least equal to that of HFCs and low discharge temperatures.
Costs, profitability (referred to a reference)	The price of these refrigerants is low, from 8 to 10 €/kg. Because of safety classification, additional costs exist to address the flammability characteristics in the equipment design. The flammability impact on the overall cost can vary significantly depending on the equipment type. Values of cost-efficiency are included in the TEAP reports (UNEP, 2011; UNEP, 2012).

Barriers and restrictions (safety, energy efficiency, etc.)	Major barriers to the use of HCs results from their flammability. Practically, this means that systems used indoor of occupied spaces will have a limited refrigerant charge. Moreover, when there is no series effect, components such as compressors cannot be commercially available with warranty. Technicians must be trained and competent in the management of HCs. Safety codes of certain buildings prohibit the use of flammable refrigerants. A complete assessment of barriers to the use of hydrocarbons and other low GWP refrigerants is available in a report by UNEP (Colbourne, 2010).
---	--

Ammonia

Ammonia is the first refrigerant use commercially in 1858 on a refrigerated boat. The water-ammonia machine has been designed by Ferdinand Carré. In 1872, the first vapor compression machine developed by Boyle uses ammonia. This refrigerant has accompanied all refrigeration developments. Ammonia is mass-produced as a basic component of fertilizers, thus it is a molecule at acceptable cost. It is moderately flammable but it is toxic from 50 ppm, which effectively limits its use in industrial facilities. Ammonia is very much used in food processes, including the U.S.

Ammonia NH ₃	R-717
Main characteristics	GWP: 0, T _{critical} : 132.3°C Normal boiling point: -33°C R-717 (ammonia) is a pure substance, safety classification B2 (toxic, low flammability) ODP = 0.
Marketing extent	R-717 is used since the 19 th century, as soon as refrigeration started; it is still widely used in food processes and since 1990 its use has been extended to medium capacity chillers (a hundred in Europe) and in very few centralized systems in commercial refrigeration via heat transfer fluids (4 to 5).
Energy efficiency (taking into account ambiance conditions)	R-717 presents thermodynamic properties favorable to evaporation temperatures higher than -33°C and otherwise require to use two-stage systems. Its volumetric capacity is similar to that of HCFC-22. However, its discharge temperatures are relatively higher.
Costs, profitability (referred to a reference)	The cost of ammonia itself is low (5 €/kg). However, the impossibility to use copper entails a significant additional cost and larger heat exchange surfaces (all things being equal). These additional costs penalize mainly small and medium-capacity systems, up to 200 kW _{cooling} , typically.
Barriers and restrictions (safety, energy efficiency, etc.)	Barriers consist in the low availability of components for low capacities. The necessary specific training of technicians to maintain charge and recover this refrigerant. The ammonia toxicity leads to the obligatory use of indirect expansion systems in commercial refrigeration with machinery rooms specifically designed for ammonia. In Europe, ammonia is classified under the Seveso Section (Section 1136 of the Environment Code), which makes declaration mandatory (charges between 150 kg and 1.5 t) and authorization for charges larger than 1.5 t.

CO₂

CO₂ is also used since the beginning of the 20th century in refrigeration systems. Unlike ammonia, its use had disappeared from the '50s given the high level of pressure. Revival occurs from 1995 under the leadership of Lorentzen, who proposed and patented a "vapor-liquid" type heat-exchanger between the compressor inlet and outlet of the gas cooler, but, because the supercritical state of CO₂ above 31°C, is actually a vapor / gas dense heat exchanger. The first main event was the development, in Japan, of the EcoCute program where the characteristics of CO₂ make possible to produce a heat pump for domestic hot water (DHW) production with annual average COP of about 3.5 to 4.

Its use in commercial refrigeration in Europe is expanding, in particular in supermarkets in transcritical mode, and in large supermarkets in CO₂ cascade at the low temperature and another refrigerant (HFC-134a for example) at the medium temperature.

CO ₂	R-744 (carbon dioxide)
Main characteristics	Safety classification: A1 ODP: 0 ; GWP: 1. T _{critical} : 31°C ; P _{critical} : 73.7 bar ; T _{triple pt} : -56°C
Marketing extent	R-744 has been used in refrigeration equipment between 1900 and 1930 prior its replacement by CFCs. Its use has been revisited in 1995 and it is now used in commercial refrigeration, food processing, heat pumps for domestic hot water (DHW) and refrigerated transports.
Energy efficiency (taking into account ambience conditions)	R-744 presents thermo-physical properties leading to reasonable COPs for condensing temperatures lower than 25°C. Operation pressure is significantly higher than that of usual refrigerants and the volumetric capacity is also high. Its use in cascade, where it is used at low temperature (evaporation between -30 and -40°C) and condensation at -10°C by another refrigerant, gives excellent energy efficiencies; it is an adopted solution in centralized commercial refrigeration and in industrial refrigeration. In transcritical cycle (T _{condensation} > 31°C) the energy efficiency is reduced and especially when the ambient temperature is high (T _{outdoor} > 25°C). For 38°C ambient temperature, the efficiency of a basic cycle is lower from 40 to 50 % than that of R-404A. 10 to 20% improvement is achievable, compared to the basic cycle, by replacing the expansion valve by an ejector (Hafner et al. 2012). Other devices can improve the energy efficiency for high ambient conditions: two-stage systems, additional sub-cooling. High discharge temperatures can be taken into account from the design stage.
Costs, profitability (referred to a reference)	The cost of the working fluid is low, typically from 3 to 5 €/kg. However, and because of the high working pressure, the choice of materials and thicknesses imply additional costs, especially for compressors. Dimensions of piping are smaller compared to current technologies, which gives the advantage of compactness of tubes and insulation materials. Necessary devices to improve the energy efficiency at high ambient temperatures entail cost increase in the range of 15 to 20%.
Barriers and restrictions (safety, energy efficiency, etc.)	Two major technological barriers are identified, the design of components and of the system for high-pressure conditions, and the degradation of performances for high ambient temperatures entail cost increase. In addition and because its unusual characteristics, technicians will need dedicated trainings and tools.

4.5 UNSATURATED HYDROFLUOROCARBONS (SAID HFOs)

HFOs (hydro-fluoro-olefins) are unsaturated HFCs because they all have a double ethylene bond, as shown on Figure 4.1. HFO denomination is often used to differentiate them from saturated HFCs of which GWP is high. Scientifically it is more appropriate to call them unsaturated HFCs.

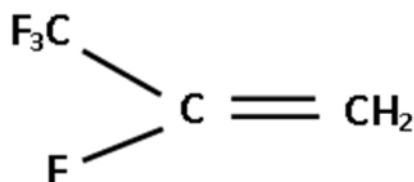

Figure 4.1 R-1234yf structure.

This double bond opens easily in presence of the oxhydryle radical $-OH$ very abundant in the atmosphere hence the extremely rapid destruction of this type of molecule in the atmosphere, with lifetimes in the range of 10 to 15 days and so very low GWPs.

HFO-1234yf	
Main characteristics	GWP: 4 $T_{critical}$: 94.7°C Normal boiling point: -29.5°C HFO-1234yf is a pure refrigerant that can replace HFC-134a in the same systems because pressure-temperature characteristics are quasi identical. It is A2L, non-toxic and very slightly flammable in the Ashrae 34 classification.
Marketing extent	R-1234yf production has been limited until the middle of 2013 when its mass production started.
Energy efficiency (taking into account ambience conditions)	This refrigerant presents efficiencies similar to that of HFC-134a, even if its theoretical COP is of few per cents lower.
Costs, profitability (referred to a reference)	Since this refrigerant is a new molecule that requires a sophisticated production process, its price is currently significantly higher (in the range of 30 to 50 €/kg) than that of HFC134a.
Barriers and restrictions (safety, energy efficiency, etc.)	New barriers are linked to the safe use of a low flammability refrigerant (A2L according to ASHRAE 34). Standards such as EN-378 and IEC-60335-2-40 are to be updated to take into account the low flammability. Precisely, this means that systems installed indoor with high charges of this refrigerant are often prohibited. Technicians will have to be well trained and competent in refrigerant management, even with low flammability. Concerns have been stated on the product associated to the decomposition of R-1234yf in the atmosphere, the TFA (Trifluoroacetic acid). A Japanese study (Kajiara 2010) shows that maximum realistic quantities of TFA will have no impacts on the aquatic environment.

HFO-1234ze(E)	
Main characteristics	GWP: 6 $T_{critical}$: 109.4°C Normal boiling point: -19°C HFC-1234ze(E) is a pure refrigerant that can replace HFC-134a in new equipments where its low volumetric capacity could be considered in their design. Its classification is A2L according to FDIS ISO 817 (low toxicity, low flammability).
Marketing extent	This refrigerant is already produced at industrial scale, as a blowing agent for insulation foams.
Energy efficiency (taking into account ambient conditions)	When this refrigerant is used in scroll or reciprocating compressors, it presents efficiencies similar to that of HFC-134a. The same POE oil can be used.
Costs, profitability (referred to a reference)	This refrigerant being a new molecule, its cost is high compared to HFC-134a, in the range of 30 to 40 €/kg. This is mainly due to its manufacturing process.
Barriers and restrictions (safety, energy efficiency, etc.)	Major barriers are related to the safe use of a low flammable refrigerant (A2L according to FDIS ISO 817). Standards such as EN-378 and IEC-60335-2-40 are to be updated to take into account less restrictive requirements for this new classification. Precisely, this means that systems installed indoor with high charges of this refrigerant are often prohibited. Also, because of the uncertainty on the future acceptance of this refrigerant, there will be gaps in the various components, including the compressor. In addition, technicians will need to be well trained and competent in low flammability refrigerant management where flammability is a key safety factor. Some building standards may prohibit the use of flammable refrigerants. The same concerns about the amount of TFA produced during the decomposition of the refrigerant into the atmosphere have been stated, the response given for R-1234yf is also valid for this refrigerant, i.e. the maximum level of TFA imaginable is well below the thresholds causing problems for marine ecosystems.

To be noted that because of the short lifetime associated to the ethylenic double bond, an HCFO containing one chlorine atom, R-1233zd, is now commercialized as blowing agent for insulation foams, and constitutes a very good refrigerant for the replacement of HCFC-123 for centrifugal chillers.

HCFO-1233zd(E)	
Main characteristics	GWP: 6 $T_{critical} = 165.6^{\circ}C$ Normal boiling point: $+ 18.3^{\circ}C$ HCFC-1233zd(E) is a pure refrigerant that reduces significantly the direct environmental impact. This refrigerant is subject to the Ashrae 34 classification and is A1 (low toxicity, non-flammable) according to ISO 817.
Marketing extent	This refrigerant is already produced at commercial scale as a solvent and blowing agent. It is expected that this refrigerant will be available upon market demand.
Energy efficiency (taking into account ambient conditions)	Used in centrifugal compressors, this refrigerant presents efficiencies slightly higher than that obtained with HCFC-123, which allows the design of higher energy efficiency systems.
Costs, profitability (referred to a reference)	Since this refrigerant is a new molecule, its costs are higher than that of HCFC-123. This cost will be moderated (in the range of 30 to 40 €/kg) and will have a reasonable return on investment because of its high energy efficiency that will decrease expenses of the end user.
Barriers and restrictions (safety, energy efficiency, etc.)	This refrigerant being non-flammable, its acceptance will be fast. Its name, type R-number is expected in 2013. The same concerns about the amount of TFA produced during the decomposition of the refrigerant into the atmosphere have been stated, the response given for R-1234yf is also valid for this refrigerant, i.e. the maximum level of TFA imaginable is well below the thresholds causing problems for marine ecosystems.

4.6 HFCs WITH GWP < 750

HFC-152a	
Main characteristics	<p>GWP: 133 $T_{critical}$: 113.3°C Normal boiling point: -24°C</p> <p>HFC-152a is a pure refrigerant that has been used for a long time in an azeotropic blend, R-500 (R-12/152a 73.8/26.2), which allowed the operation of systems designed for moto-compressors of 60 Hz in 50 Hz because R-500 presents a volumetric capacity 20% higher than that of CFC-12. This blend has been abandoned in the 90s with the Montreal Protocol implementation.</p> <p>HFC-152a has been assessed as a pure refrigerant in the 90s to replace CFC-12 in domestic refrigeration but it has not been used. It was primarily evaluated in the 2000s as a replacement for HFC-134a in mobile air conditioning; its GWP < 150 served as a reference to Directive 40/2006. It is classified 2 for flammability as its burning velocity of 23 cm/s is above the threshold of 10 cm/s, which defines the 2L class. It is one of the components of low-GWP refrigerant blends.</p>
Marketing extent	HFC-152a is widely used, such as in aerosol cans, because it has very good solvation properties and is less flammable than hydrocarbons
Energy efficiency (taking into account ambience conditions)	The HFC-152a energy efficiency is close to that of HFC-134a in mobile air conditioning and in domestic refrigeration but adaptations have to be made to take into account its evaporation pressure, which is lower than that of HFC-134a. Test results concern only prototype systems because of the lack of commercialized references.
Costs, profitability (referred to a reference)	The direct cost of this refrigerant is in the same range as HFC-134a. The molecule is produced in China and its manufacturing process does not present any specific difficulties.
Barriers and restrictions (safety, energy efficiency, etc.)	Main constraints are related to the safe use of a flammable refrigerant (Class 2). A priori, its plausible future uses are in low-GWP refrigerant blends.

HFC-32

Main characteristics	GWP: 716 $T_{critical} = 78.1^{\circ}C$ Point normal d'ébullition: $-51.7^{\circ}C$ HFC-32 is a refrigerant used as an R-410A component (HFC-32/125, 50/50) and also of R-407C (HFC32/125/134a, 23/25/52) and of all various R-407. Its GWP presents a significant reduction compared to R-410A, HCFC-22 or R-407C. Its pressure and its volumetric capacity are 1.5 higher than that developed by HCFC-22 and 10% higher than that of R-410A. Classified 2L by Ashrae 34, it is also a component of new low-GWP blends. Will it be used as a pure refrigerant to replace R-410A? The answer seems to be yes in South-East Asia. Will the European regulation consider it as a long term candidate? This is an open question.
Marketing extent	Since HFC-32 is a component of R-410A and of R-407C, it is mass produced; its availability as a pure refrigerant is not yet widespread.
Energy efficiency (taking into account ambience conditions)	The energy efficiency of systems using HFC-32 is similar to that of R-410A systems and the COP of systems developed specifically for HFC-32 is at least 5% higher than that of R-410A, especially for high condensation temperatures. The HFC-32 charge is lower than that of R-410A because of its lower liquid volumetric mass. The oil viscosity (POE or PVE) has to be adapted to operation conditions. HFC-32 presents heat transfer and transport properties better than that of R-410A. The discharge temperature is high compared to that of R-410A, which can lead to the implementation of specific cooling devices.
Costs, profitability (referred to a reference)	The direct cost of this refrigerant is lower than that of R-410A. Control devices may constitute an additional cost.
Barriers and restrictions (safety, energy efficiency, etc.)	Main constraints are related to the safe use of a low flammability refrigerant (2L according to Ashrae 34).

4.7 BLENDS OF HFOs AND HFCs

Refrigerant changes, from CFCs to HFCs or HCFCs, then from HCFCs (mainly HCFC-22) to HFCs, have led to an offer of refrigerant blends of transition that, by definition, have a lifetime limited to the life extension of installations which amortization justified the retrofit operation.

The move of high-GWP to low-GWP refrigerants occurs within an uncertain regulatory context, nobody being able to define what will be high and what will be low on the long term, the large number of refrigerant candidates to the replacement of R-410A, R-404A and HCFC-22 are presented successively with reference to refrigerants they replace.

Note: refrigerants for intermediate replacement exist for HFC-134a; they are not presented since R-1234yf and R-1234ze are well-established to replace HFC-134a and the fact that their respective GWP is 4 and 6 make other candidates appearing short term.

Candidates to replace R-410A

Data for volumetric capacities and COPs are based on AHRI Test report no. 1, measured on a volumetric air/water chiller; TC and TNe are calculated with Refprop 9.0, GWP calculations are based on OMN 2010.

Table 4.6 Characteristics of refrigerant candidates to replace R-410A.

Commercial name	Components and compositions	GWP	T _{critical} et T _{normal} boiling (glide)	Volumetric capacity referred to R-410A	COP relative to COP R-410A
R-410A	HFC-32/125 50/50	2100	TC = 71.4°C TNe = -51.4°C	1	1
ARM-32	HFC-32/125/134a/1234yf 25/30/25/20	1579	Tc = 83.3°C TNe= -42°C (-39/-45°C)	1.08	0.98
ARM-70	HFC-32/134a/1234yf 50/10/40	497	TC = 86.9°C TNe= -43.5°C (-41/-46°C)	0.89	1.07
DR-5	HFC-32/1234yf 72.5/27.5	524	TC = 83.2°C TNe = -47.5°C (-45.6/-49.4°C)	1.02	1.04
L-41a	HFC-32/1234yf/1234ze 73/15/12	524	TC = 81.8°C TNe = -48°C (-46.2/-49.8°C)	0.98	1.03
L-41b	HFC-32/1234ze 73/27	524	TC = 80.5°C TNe= -48.2°C (-46.5/-50°C)	0.96	1.04
HFC-32		716	TC = 86.9°C TNe = -51.7°C	1.12	0.98

The analysis of Table 4.6 shows that a number of candidates to replace R-410A are proposed and that:

- The objective is to replace HFC-125 with GWP of 3420
- all candidates contain HFC-32, which is essential to obtain an identical or close volumetric capacity
- the blend ARM-32 is a transition blend with a GWP higher than that of HFC-134a
- the GWP of replacement blends is around 500,

- to obtain a volumetric capacity almost identical implies that the blend includes at least 70% of HFC-32
- HFC-32 leads to a volumetric capacity greater than 12% compared to R-410A
- All refrigerant blends present a temperature glide to the phase change that varies from 4 to 6°C.

Note on blends with temperature glide: *pure refrigerants or azeotropic blends (series 500) condense or evaporate at constant pressure AND temperature, refrigerant blends of series 400 condense or evaporate at constant pressure AND temperature glide, which means that the liquid saturation temperature is lower than the vapor saturation temperature for the same pressure. R-410A is a near azeotropic refrigerant blend with temperature glide in the range of 0.1°C while refrigerant blends candidate to its replacement present temperature glides of several degrees Celsius.* The temperature glide can present advantages and disadvantages. Among its advantages: minimization of the temperature difference with an external refrigerant of which the temperature varies strongly between the heat-exchanger inlet and outlet. Disadvantages: earlier frosting, difficulty of the superheating control especially when the replacement is made with a “drop-in” refrigerant. The temperature glide indicates also that in case of leak, the most volatile component of the blend will escape preferentially and that the blend formulation will change.

Some characteristics are generic. For COPs, optimization developments lead to energy-efficiency improvements. Other measurements on other equipment are necessary to establish a more complete comparative table. However, first orders of magnitude are known and the chemical engineering proposes candidates with performances close to that of R-410A with GWPs around 500.

Candidates to R-404A replacement

Data on COPs and volumetric capacity are based on “AHRI Test report no. 9” on a refrigeration group of a truck autonomous refrigeration system. TC and TNe are calculated based on Refprop 9.0, GWPs are calculated based on OMN 2010 data.

Table 4.7 Candidates to the replacement of R-404A.

Commercial name	Components and compositions	GWP	T _{critical} et T _{normal} boiling (glide)	Volumetric capacity referred to R-404A at -29°C	COP relative to COP R-404A
R-404A	HFC-125/143a/1340 44/52/4	3700	TC = 72°C TNe = -46.2°C	1	1
ARM-30a	HFC-32/1234yf 29/71	210	T _c = 90.2°C TNe = -39°C (-36.7/-41.4°C)	0.81	0.89
DR-7	HFC-32/1234yf 36/64	259	TC = 89.2°C TNe = -40.7°C (-38.2/-43.2°C)	1.02	1.07
L-40	HFC-32/152a/1234yf/1234ze 40/10/20/30	302	TC = 89.9°C TNe = -40.8°C (-37/-44.6°C)	0.83	0.86

The analysis of Table 4.7 shows that candidates to R-404A replacement present the following characteristics:

- All candidates contain HFC-32 and R-1234yf
- GWP of refrigerant blends to replace R-404A range from 200 to 300,

- Critical temperatures are higher and allow the replacement of HCFC-22 in commercial refrigeration
- All refrigerant blends present a temperature glide that phase change that varies from 4 to 7°C, which avoids these refrigerants to be used in systems with recirculation by pump and more generally in flooded evaporators, since these blends will distillate and their composition will change as a function of their operation duration.
- DR-7 is formulated for lower evaporation temperatures and its COP is higher than that of R-404A
- L-40 and ARM-30a are too low in volumetric heating capacity (-20%) at low evaporation temperature and high condensation temperature
- Very sensible temperature differences (COP and cooling capacity) between ARM-30a and DR-7 seem surprising when finding that components are identical and compositions very close.

Candidates to HCFC-22 replacement

Data on COPs and volumetric capacity are based on “AHRI Test report no. 6” on an air/water volumetric chiller. TC and TNe are calculated with Refprop 9.0, and GWPs are calculated based on OMN 2010 data.

Table 4.8 Candidates to HCFC-22 replacement.

Commercial name	Components and compositions	GWP	T _{critical} et T _{normal boiling} (glide)	Volumetric capacity referred to HCFC-22 at T _{water outlet} 7°C	COP relative to COP HCFC-22
HCFC-22		1790	TC = 96.1°C TNe = -40.8°C	1	1
ARM-32a	HFC-32/125/134a/1234yf 25/30/25/20	1548	Tc = 83.3°C TNe = -42.3°C (-39.3/-45.3°C)	1.06	0.93
DR-7	HFC-32/1234yf 36/64	259	TC=89.2°C TNe = -40.7°C (-38.2/-43.2°C)	1.1	0.93
L-20	R32/152a/1234yf/1234ze 40/10/20/30	302	TC = 89.9°C TNe = -40.8°C (-37/-44.6°C)	1	0.98
LTR4X	HFC-32/125/134a/1234ze 28/25/16/31	1276	Tc = 83.2°C TNe= -42.2°C (-38.4/-46.1°C)	1	0.95
LTR6A	HFC-32/744/1234ze 30/7/63	219	Tc = 87.9°C TNe = -45.6°C (-35/-56.2°C)	1.01	0.98
D52Y	HFC-32/125/1234yf 15/25/60	965	Tc = 85.7°C TNe = -39.6°C (-37.2/-42°C)	0.95	0.93

The analysis of Table 4-8 shows that candidates to HCFC-22 replacement present the following characteristics:

- all candidates contain HFC-32 and R-1234yf or R-1234ze
- GWP of blends ARM-32a, LTR-4X and D52Y present too high values to be long-term candidates

- DR-7 is proposed to replace HCFC-22 as well as R-404A
- COPs of efficiency need to be improved
- All blends present a temperature glide at phase change that varies between 5 and 7°C and even 21°C for LTR-6A because of 7% CO₂ content
- DR-7 is formulated for lowest evaporation temperatures and its COP is significantly higher than that of R-404A

5. ANALYSIS OF ALTERNATIVES BY KEY SECTOR OF REFRIGERATION AND AIR CONDITIONING

Section 5 gives in its first quantitative analysis of the structure of refrigerants by application in agreement with the split chosen by the report of technical option of UNEP. Once this quantitative analysis is established, each application sector is quickly described to facilitate the understanding of factsheets by application, which format have been explained in Section 2-4 and which, for reasons of clarity, are reported in a separate annex due to their format (A3). These factsheets are read preferably in parallel to each section.

5.1 REFRIGERANT BANKS IN EACH APPLICATION SECTOR

Refrigerant inventory studies allow the knowledge of refrigerant quantities that constitute banks⁴ by application. Here are presented only the HFC banks in France, highlighting applications that use widely high-GWP HFCs.

Results presented in this section are based on the most recent inventory report published [BAR 12], corresponding to year 2011 released in 2012. They do not take into account corrections or updates realized within the scope of 2012 inventories to be released end of December 2013.

The HFC bank is estimated to 43,400 t at the end of 2011 in France [BAR12] dominated by the mobile air-conditioning sector. Sections of the air-air conditioning (SAC), chillers, industrial and commercial refrigeration, are then sectors the most representative of the HFC bank (12 to 14%).

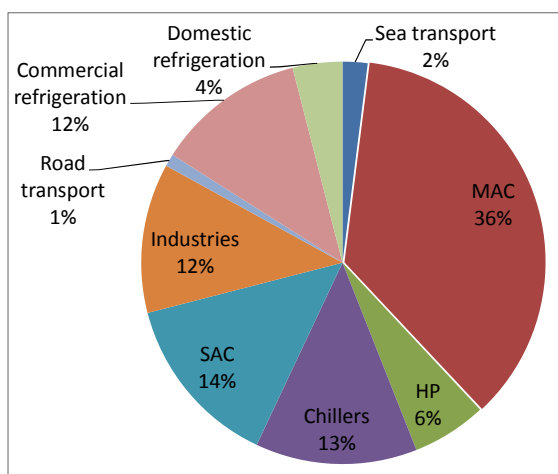

Figure 5.1 Structure by sector of the HFC bank in France in 2011

Table 5.1 HFC banks by sector and by refrigerant - France 2011

BANK 2011	HFC-134a	R-404A	R-407C	R-410A	R-507	R-417A	R-422A	R-422D	R-427A
TOTAL	22,805	7,171	5,213	6,769	422	172	70	604	204
Domestic refrigeration	1,675	-	-	-	-	-	-	-	-
Commercial refrigeration	701	3,295	6	22	406	7	24	87	22
Road transport	38	324	-	1	-	-	-	-	-
Industries	1,768	2,913	236	107	16	48	46	134	30
SAC	188	-	1,844	4,048	-	14	-	5	-
Chillers	2,018	-	2,493	816	-	-	-	378	153
HPs	141	-	554	1,776	-	101	-	-	-
MAC	15,483	-	80	-	-	0	-	-	-
Sea transport	793	9	-	-	-	-	-	-	-

⁴ The bank corresponds to overall quantities of refrigerants contained in all equipments installed in France (installed base). One can also talk of the "stock" of refrigerants contained in equipments.

Except HFC-134a, strongly used in mobile air conditioning, sectors concerned by high HFC banks are as follows:

- Commercial refrigeration and industry for R-404A
- Commercial refrigeration also for R-507A
- chillers and stationary air conditioning for R-407C and R-410A
- Commercial refrigeration, industry, and chillers for the so-called “replacement” refrigerants (R-422D, R-422A, R-427A, R-417A).

Moreover, the estimation of emission rates by sector and the knowledge of the installed base allow the evaluation, by refrigerant, of HFC quantities needed for the equipment maintenance. The HFC demand necessary for the maintenance of equipment of the French installed base is estimated to 3900 tonnes in 2011. Commercial refrigeration is the dominant sector, almost 30%, followed by industrial refrigeration (23%).

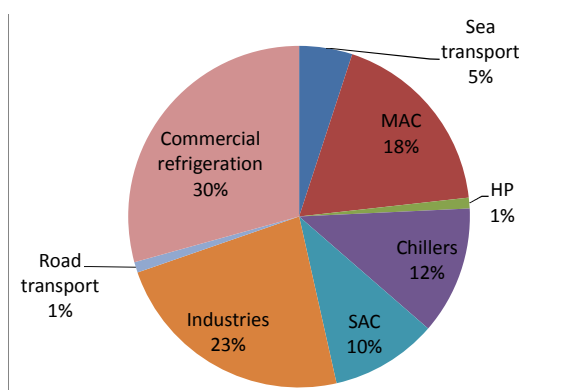

Figure 5.2 Structure by sector of the HFC demand needed for the maintenance of equipment of the French installed base in 2011.

Table 5.2 HFC demand for the maintenance of equipment by sector and by fluid - France 2011

Maintenance 2011	HFC-134a	R-404A	R-407C	R-410A	R-507	R-417A	R-422A	R-422D	R-427A
TOTAL	1,474	1,467	461	332	108	11	9	31	7
Domestic refrigeration	0	-	-	-	-	-	-	-	-
Commercial refrigeration	65	933	2	6	107	2	3	10	3
Road transport	12	70	-	0	-	-	-	-	-
Industries	336	462	40	18	1	7	6	21	5
SAC	14	-	161	216	-	-	-	-	-
Chillers	149	-	228	70	-	-	-	0	0
HPs	4	-	26	22	-	2	-	-	-
MAC	707	-	3	-	-	-	-	-	-
Sea transport	187	2	-	-	-	-	-	-	-

Table 5.2 shows clearly the high level of R-404A demand for maintenance (equivalent to 20% of the R-404A bank) compared to the level of banks in the previous table.

- **Commercial and industrial refrigeration are the two sectors in the most critical situation vis-à-vis high-GWP HFCs: their banks of R-404A are significant but also, annual quantities necessary to the maintenance of the installed bases are high.**

It should be noted that in the context of the update of inventory studies for the year 2012, a correction was made on historical levels of centralized commercial refrigeration and food processes. The results of the demand estimation for the maintenance of installations working with R-404A, presented above, are underestimated by about 20%.

Annex 9 details the analysis of the structure of banks and of the demand for maintenance of installations by refrigerant and by sub-sector for R-404A, R-410A, R-407C, and HFC-134a. It shows in

particular that large supermarkets, supermarkets, warehouses and condensing units for small stores are applications for which R-404A bank are the most significant. R-404A demand for maintenance of installations is however strongly dominated by centralized direct expansion systems in large supermarkets and supermarkets.

Within the scope of this study, the development of the HFC demand **for the maintenance of the installed base in France at the end of 2012** has been established. The calculation is based on the knowledge of the installed base and the age of equipment at the end of 2012, assuming that annual emission rates are constant. The demand, presented Figure 5.3, corresponds to HFC quantities needed to service equipment already installed in France in 2012, and taking into account their “natural” end of life, as a function of the average lifetimes by application. It corresponds to a minimum demand, since it does not take into account the demand generated by new equipments using HFCs that will be commercialized after 2012. This estimate considers a correction factor to take into account the update related to 2012 inventories (especially the difference on the R-404A market).

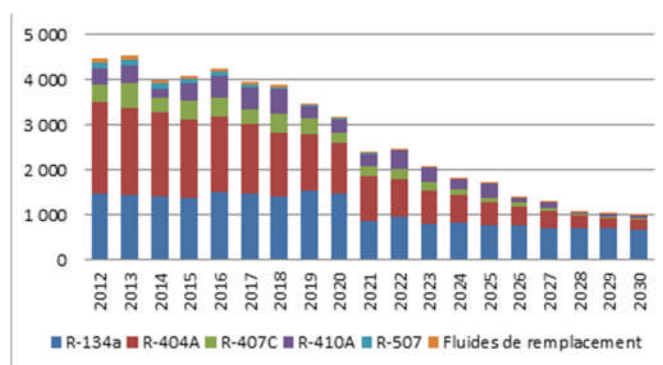

Figure 5.3 HFC quantities (t) needed for the maintenance of equipments in France in 2012.

We observe that, given the lifetimes of certain facilities and the recent renewal of sectors formerly users of HCFC-22, the HFC demand for the maintenance of installations of the French installed base in 2012 persists through 2030, in the range of 1000 t per year.

Figure 5.4 presents this same demand in CO₂ equivalent. GWPs given by the 4th Assessment Report of IPCC have been taken into account for this calculation because they are the reference used in these revision proposals of Regulation EC 842/2006. This demand, in the range of 12 million of tonnes of CO₂ equivalent, reduces progressively, due to end of life of installation, but remains in the range of 2 million of tonnes of CO₂ equivalent in 2030. Except if retrofit of installations with HFCs are implemented, quantities needed for the maintenance of current installations will remain high and to be taken into account in the quantities authorized for commercialization within the scope of the “phase down”.

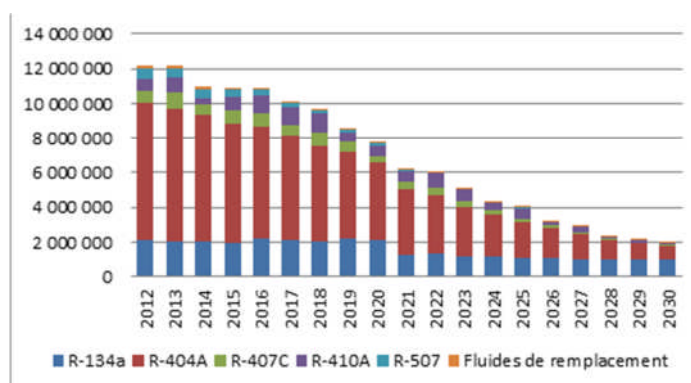

Figure 5.4 HFC quantities (t of CO₂ equivalent) needed for the maintenance of equipments in France in 2012

The last French OFF report (Refrigerant Observatory) of ADEME mentions the quantities of HFCs declared for commercialization from 2009 to 2012 in tonnes of CO₂ equivalent. The average figure from 2009 to 2012 is of 25.7 million tonnes of CO₂, not including pre-charged equipment (which corresponds to the reference volume given in the regulation revision). Thresholds of quantities authorized for commercialization will concern Europe and the phase down is not applicable by country. However, if the proposed levels for Europe were to be applied to the French level, the order of magnitude would be of 25.7 million of tonnes of CO₂ authorized to be placed on the French market in 2015 to reach 16.2 million in 2018, and 4.1 million in 2030 (the lowest level given by the Parliament). These levels tend to show that a significant part of quantities authorized to be placed on the market should be dedicated to the maintenance of the current installed base, if a retrofit of installations using high-GWP HFCs is not scheduled by 2020.

5.2 DOMESTIC REFRIGERATORS AND FREEZERS

This is a mature market (Table 5.3) with no production in France and a regular increase of the R-600a penetration since 1995, which replaces progressively HFC-134a.

Table 5.3 Sales of refrigerators and freezers [GIF11].

Markets of new equipment	2009	2010	2011	2012
Refrigerators	2,300,000	2,550,000	2,572,000	2,535,000
Freezers	720,000	735,000	724,000	690,000

Since 2010, 95% of refrigerators and freezers are charged with R-600a. The remaining 5% are charged with HFC-134a.

In this sector, the only HFC used is HFC-134a. Whether refrigerators, combined (Factsheet DR1 or freezers (Factsheet DR2), the alternative available since several years is R-600a. Its main drawback is its flammability class (Class 3, hydrocarbon), but compensated by a very low charge and a sealed system.

5.3 COMMERCIAL REFRIGERATION – DISPLAY CASES AND COLD ROOMS FOR LARGE AND MEDIUM SALES AREAS

5.3.1 Presentation of the sector

The commercial refrigeration sector is composed of four sub-sectors with equipments of different sizes and structures:

- large supermarkets,
- supermarkets,
- condensing units for small stores,
- stand-alone systems including vending machines for small stores.

Large supermarkets and supermarkets are equipped with centralized systems, with a machinery room where two series of compressor racks operate, one between -10 and -15°C for the conservation of fresh food and the other in the range of -35 to -38°C for frozen food. It has to be noted that 85% of the refrigerating capacity and 75% of the refrigerant charge are in the medium-temperature compressor racks (-10 à -15°C).

“Small stores” are equipped with condensing units or stand-alone equipment. These equipments are used in small food stores, bars, hotels and restaurants, gas stations and highway gas-stations. Vending machines for cold drinks are stand-alone equipment.

Within the scope of inventories, ARMINES carried out case studies on site, which showed that ratios of refrigerant charge per m² could be established for large supermarkets and supermarkets, and that sales areas are accessible data statistically in France and in most European countries.

Table 5.4 New sales areas in large supermarkets in France from 2009 to 2012.

LARGE SUPERMARKETS	2009	2010	2011	2012
Number of stores	1526	1748	1827	1968
Average store surface (m ²)	5561	27	5416	5400
New sales areas (m ²)	355,079	1,158,066	220,935	369,000

As shown in Table 5.5, R-404A is the most dominant refrigerant because of its polyvalence in medium- and low-temperature where medium-temperature (-12 °C) and low-temperature compressor racks (-38 °C) operate with this refrigerant. In this sector, the reference system, dominating the new equipment market for several years is **the centralized direct expansion system using**

R-404A in low and medium temperature. In 2011, the R-404A bank in commercial refrigeration was about 5,800 metric tonnes, of which 1 700 metric tonnes in large supermarkets.

Table 5.5 Refrigerants in the new equipment market in large supermarkets

Large supermarkets - New installations	R-404A/ R-507A	HFC- 134a	R-410A	R-407C	CO ₂
2011	82%	10%	2%	0%	5%

It has to be noted that the large supermarket concept develops only in countries where daily opening hours are of 12 hours, from 9:00 am to 9:00 pm, and that these stores do not exist in Northern Europe, except in Great Britain. Refrigerating capacities are four times greater in average than that of compressor racks in supermarkets, and consequently different technical options exist.

The number of supermarkets is well known (see Table 5.6).

Table 5.6 Evolution of the number of supermarkets in France from 2009 to 2012 (INSEE source).

SUPERMARKETS	2009	2010	2011	2012
Number of stores	5437	5381	5507	5702
Average store surface (m ²)	1284	1288	1304	1320
New sales areas (m ²)	18,570	0	250,400	122,357

The fluid distribution in supermarkets is somewhat oriented towards HFC-134a due to the smaller size of installations, but R-404A is always the dominant fluid (Table 5.7).

Table 5.7 Refrigerants in the new equipment market in supermarkets

Supermarkets - New installations	R-404A	HFC-134a	R-410A	CO ₂
2010	87%	12%	1%	0%
2011	78%	20%	1%	1%

The R-404A bank in supermarkets is evaluated to 1250 metric tonnes in 2011 [BAR12] and at 1350 metric tonnes in 2012.

The installed base of installations in small stores is less precisely known. Estimation can be made based on the number of small stores. Refrigerants used are HFC-134a, dominant in stand-alone, and R-404A prevails in condensing units. The refrigerant bank in small-store installations is estimated as follows:

- 500 metric tonnes of refrigerants in display cases using stand-alone in 2011, of which 4/5 of HFC-134a and 1/5 of R-404A
- 1300 metric tonnes of refrigerants in display cases with condensing units, of which 850 metric tonnes of R-404A and nearly 200 metric tonnes of HFC-134a

5.3.2 Alternatives to direct expansion systems using R-404A in low-temperature only or low-temperature and medium-temperature refrigeration systems (factsheet CR1)

Several alternatives to R-404A use in direct expansion systems are available on the European market and have been implemented for several years (Factsheet CR1).

In large supermarkets, where the refrigerating capacity at -12°C is in the range of 800 kW and from 125 to 200 kW for low temperature (-38 °C) with several compressor racks installed in a machinery room, the most advanced concept is to operate with direct expansion systems, with CO₂ at the low temperature and condensation around -10°C on HTF circuit, which constitutes the indirect expansion system at the medium temperature with compressor racks using HFC-134a. Already more than 400 installations of this type exist in large supermarkets and supermarkets [PER13]. For the future, R-1234yf will replace easily HFC-134a.

Another alternative is the transcritical CO₂ solution but, even is using a refrigerant with GWP = 1, several disadvantages exist: the operation pressure is high and may cause safety and reliability issues; it is not adapted to hot climate, the investment cost is high, training is required for maintenance [BIT09].

For supermarkets, several key new technologies have been implemented in counties of Northern Europe and at a lesser extent in France, e.g. the installation of refrigerating units operating with CO₂ at the low and medium temperatures and cascade architecture. For cooling capacity at -12°C, CO₂ operates with a usual phase-change cycle for outdoor temperatures up to 18 to 20°C and condensing pressure higher than 5 MPa. Beyond, the cycle will be transcritical with high pressure from 9 to 10 MPa, which requires heat exchangers with specific design. Throughout Europe, more than 1300

stores are equipped with these systems (including in CO₂/HFC-134a cascade) on a total of 20,000 European supermarkets and 4 million of mini-markets.

Currently no refrigerant available exists for R-404A retrofit in centralized commercial refrigeration allowing the retrofit of low-temperature and medium-temperature refrigeration systems. R-407F and R-407A are proposed as “drop-in” replacement refrigerants of R-404A for medium-temperature refrigeration systems and, tested in supermarkets they present energy efficiency close to that of R-404A [DAN13].

Alternatives under development

Main refrigerants candidate to R-404A replacement, under development, have been presented in Section 4 (Table 4.7). Their GWPs are between 200 and 300 because the HFC-32 concentration remains equal or lower than 40%. These refrigerants are mentioned in application factsheets presented in Annex 9. These first refrigerants, proposed and tested within the AHRI program, but for other applications, are good candidates to replace R404A in commercial refrigeration; however, they present the disadvantage to be slightly flammable.

5.3.3 Alternatives to stand-alone using HFC-134a

In small-store equipments, the trend observed these past years is the introduction of stand-alone display cases operating with propane (R-290) with charges of at least 500 g; isobutane is also found in ice-cream freezers. Thus, these available alternatives present a major disadvantage: the flammability level (Class 3), which is certainly associated with a reduced charge, but the number of equipments can be high in a same store and the owner is not always aware of its ATEX obligations (total charge referred to the sales area). To be noted that for these equipments, as for beverage vending machines, equipments belong to the brand-name manufacturers that rent them to the stores.

Some vending machines operate with CO₂ and not with propane, due to the charge that can be greater than 1 kg. This non-flammable alternative is interesting but the technical level is so high that only one company commercializes currently this type of equipment (cost and competition issues).

Alternatives under development

Among HFC/HFO blends under development, refrigerants with GWP around 600 are currently tested: XP-10 or N-13 (Factsheet CR1). R-1234yf and R-1234ze are also under test and should replace easily HFC-134a.

5.3.4 Alternatives to condensing units using R-404A

For new equipments, condensing units using HFC-134a are an alternative commercially available since several years; they operate with larger compressors that are also slightly more expensive. There is currently no alternative and no refrigerant is suitable for retrofit (given the cost of this type of equipment, retrofitting is all an uncommon way operation).

Alternatives under development

Several refrigerants under development and adapted to condensing units should appear rapidly on the market (in 2 to 3 years), especially slightly flammable blends with GWP between 200 and 300 (Factsheet CR2),

5.3.5 Conclusions

In summary, for high-cooling capacity installations in large supermarkets, the future concept will limit drastically the charge at the medium-temperature level (-12°C) using either HFC-134a (short term) or

CO₂ or R-1234yf (medium term) assisted with a secondary loop, the low-temperature level operating with CO₂ in direct expansion system. This same concept can also be used in supermarkets where the refrigerating system can operate fully with CO₂ depending on the latitude and the number of hours with outdoor temperature higher than 20°C.

For condensing units that are generic it is likely that blends with GWP around 300 will replace R-404A, since ATEX precautions for very low flammable mixtures are strongly different from those required for hydrocarbons. Finally, for stand-alone equipment, the choice will be between the HFO/HFC blends, propane, CO₂ and R-1234yf.

5.4 REFRIGERATED TRANSPORT

In Europe, it is estimated that some 400 millions of tonnes of food per year are carried by road refrigerated transport and the consumption of frozen food continues to rise. In order to respect the cold chain and regulatory temperatures imposed by the hygiene package, the installed base of vehicles is composed of vans and small vehicles (load capacity <3.5 tonnes), trucks and carriers (> 3.5 tons), trailers and semi-trailers (20-24 tons).

Temperature ranges to respect are -18°C for frozen food and temperatures from 2°C to 8°C for refrigerated products. Most recent data on the vehicle installed base of refrigerated transport are established by Cemafruid.

Table 5.8 Number of refrigerated vehicles and containers in 2012.

Vehicle type	Number of vehicles and containers in service in 2012
Trucks	27,087
Vans	62,881
Containers	1,537
Trailers	470
Semi-trailers	28,908
TOTAL	120,883

Currently, HFC-134a is used for refrigeration capacities lower than 3500 W. For trucks, trailers and semi-trailers R-404A is the chosen refrigerant. R-404A is also used in small systems, direct-drive type, for maintenance simplicity.

Technical data typical of different types of refrigeration systems are presented Table 5.9.

Table 5.9 Characteristics of refrigeration systems.

Technology	Refrigeration capacity (W)	Average charges (kg)
Pulley-belt	500 à 3000	1.6
Splits	2500 à 5500	4
Condensing units	6000 à 10000	7

Refrigeration systems of direct-drive types are small equipment mounted on vans and other small vehicles. Their compressor is driven by the vehicle engine. Split types are self-powered units, directly mounted under the chassis or on the isothermal casing. Refrigeration systems are self-powered units, integrated in the front of a trailer. Usually they are high-capacity and are intended for long-distance transport.

Because of their difficult conditions of use, these equipments imply quite high refrigerant leak rate

Table 5.10 Evaluation of refrigerant quantities used in refrigerated transport in France.

Refrigerant	Number of vehicles	Refrigerant quantity (kg)
HFC-134a	17,169	16,022
R-404A	99,793	336,687
Others	3,471	14,847
TOTAL	120,883	367,557

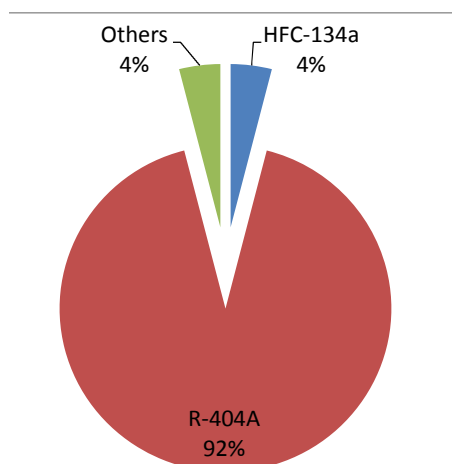

Figure 5.5 Distribution of refrigerants in refrigerated systems of road transport in 2012.
Alternative technologies

Different refrigeration technologies exist that do not use high-GWP HFC compression systems. They are briefly presented in next paragraphs.

- Some vehicles use cold storage system: they usually transport frozen products such as ice creams and in general they are equipped with wickets for limiting air entries. Often, they are not really adapted to long-distance transport and their used is dedicated to city transport. Main difficulties characteristics to this technology are the useful load capacity affected by the weight of the cold storage (eutectic) and additional means needed to freeze eutectics (often a device with its own compression system)
- Direct or indirect cryogenic system: they appeared a few years ago; these systems offer the advantage of silent vehicles well-suited to urban deliveries. Their use for long-distance transport is less suitable because of the absence of a nitrogen supply network. Direct expansion systems where nitrogen is released in the transport volume generates safety problems, managed by automated control systems integrated to the vehicle. These systems cannot be used to transport products such as live shellfish.
- CO₂ compression systems: this technology is not available yet, but has been proven for containers. This is probably the most credible alternative for refrigerated equipment since use restrictions are low or even nonexistent. Technology, however, must be adapted to highly variable European climates.

5.5 REFRIGERATION IN FOOD PROCESSES

In food processes, four large categories of refrigeration needs exist:

- For warehouses (medium-temperature or low-temperature refrigeration)
- Process cooling (medium-temperature refrigeration)
- Freezing processes (low-temperature refrigeration)
- Ambiance conditioning (medium-temperature or low-temperature refrigeration).

To satisfy these needs, installations can present several structures:

- Direct expansion systems adapted to different refrigeration capacities, centralized systems with independent machinery room with refrigerant direct expansion
- Indirect expansion systems using MPG or CO₂ as heat transfer fluid, which is cooled by the thermodynamic system operating with a refrigerant
- Cascade systems with two distinct refrigerants, one adapted to high temperature, i.e. HFC-134a, the other at the low temperature, i.e. CO₂, the high-temperature refrigerant condenses the low temperature refrigerant by evaporation in an evaporator-condenser
- Two-stage systems (booster) that use the same refrigerant at the two temperature levels
- Systems with recirculation by pump feeding high-capacity evaporators and operating mainly at low temperature; these systems require pure refrigerants or quasi-azeotropic refrigerants
- Systems with flooded evaporators such as milk tanks
- Chillers

The choice of the installation depends on:

- The level of the operation temperature,
- The refrigeration capacity needed (itself function of the production),
- The cooling means of the condenser (air, water, cooling tower, etc.)
- The desired energy efficiency,
- The budget.

In France, in terms of installations, food processes represent:

- about 720 refrigerated warehouses, representing 15 million of m² [DEV12]
- 13,500 food companies of which 2,500 in the meat industry, 1,250 in the milk industry, 300 in the fish industry, 1,350 in the manufacturing of bread and pastries, and 2,600 in the beverage processes [PAN12]
- 170,000 milk tanks are installed in milk farms.

REFRIGERANTS AND BANKS

The present refrigeration production in industrial and food processes uses mainly HCFC-22, R-404A, HFC-134a, and ammonia (R-717) as refrigerants. CO₂ (R-744) begins to be used in low-temperature refrigeration, in cascade with ammonia or HFC-134a. Indirect expansion systems with heat transfer fluids have always existed and are associated to different refrigerants.

According to results of inventories 2011 [BAR11], the bank of refrigerants of the food sector is estimated to 8,100 metric tonnes of which 30% of R-404A, 19% of HCFC-22, and 45% of R-717.

Table 5.11 Refrigerant banks in food processes in France.

Food processes bank (metric tonnes)	R-404A	R-717 (NH ₃)	HCFC-22	HFC-134a	R-744 (CO ₂)	Replacement refrigerants
2011	2420	3680	1550	210	15	250
Estimation 2012	2600	3730	1320	250	35	270

In this sector, reference systems identified as using high-GWP HFCs, here R-404A, are as follows;

- Direct centralized systems or operating also as indirect expansion systems for medium-temperature installations (Factsheet FP1)
- Direct centralized systems or operating as indirect expansion systems for medium-temperature and low-temperature installations, or low-temperature only (Factsheet FP2)
- Systems with flooded evaporators for medium-temperature installations (Factsheet FP3)
- Systems with flooded evaporators for low-temperature installations (Factsheet FP4),

Direct expansion systems used in milk tanks are included in flooded-evaporator systems (Factsheet FP3). Thus they cannot operate with high-temperature glide blends.

Chillers used in food processes will be treated in the “chillers” section.

ALTERNATIVES TO SYSTEMS USING HIGH-GWP HFCs

Alternatives to direct or indirect medium-temperature systems using R-404A

New installations

- Among installations recently placed on the market because of the ammonia regulation flexibility, systems using R-717 are more and more present on the new equipment market. They constitute the first existing alternative to direct or indirect expansion systems using R-404A (Factsheets FP1 and FP2)
 - the main disadvantage of this type of installation is its cost: the investment is significantly higher than that of a R-404A one and specific constraints linked to the toxicity and flammability of R-717 are also expensive (installation of equipment for concentration controls, ventilated machinery rooms with alarm, etc.)
 - lessons learned from surveys show that the choice of ammonia is strongly related to the strategy and the experience of the company: when the company is expert in safety management, it can make the choice of investment in exchange for an insurance vis-à-vis of possible regulation changes concerning the use of HFCs.
- HFC-134a is also an available alternative to R-404A. It can be used in direct expansion systems but can also be arranged in indirect expansion system in order to limit the installed refrigerant charge and the environmental impact of the installation.
 - Disadvantages of this type of installation are linked to HFC-134a use that presents a lower volumetric capacity than that of R-404A.
 - The main interest is the strong reduction of the environmental impact of the installation, especially since it is possible to design new facilities to consider further retrofit from HFC-134a to R-1234yf.

Retrofit

R-407A (GWP = 2100) and R-407F (GWP = 2060) are now available as first solution for the replacement of R-404A in direct expansion systems. Based on survey results, the retrofit of installations from R-404A to R-407A (or R-407F) did not require any component replacements. Refrigerants developed for HCFC-22 replacement can also be used for R-404A (GWP = 3700) replacement, R-407A and R-407F with lower GWPs.

Alternatives to low-temperature refrigeration systems (or medium and low-temperature) using R-404A

- Alternatives existing for R-404A medium-temperature refrigeration systems mentioned here above can be used for low-temperature refrigeration systems or medium and low-temperature refrigeration systems. However, more energy and environmental efficient options exist.
- Cascade type systems use CO₂ at the low-temperature stage with HFC-134a or R-717 at the medium temperature stage either in direct or indirect expansion systems. These systems are alternative to systems using R-404A. Another option exists, constituted by a two-stage system with ammonia at both stages such as Booster type.
 - Cascade systems are very energy efficient, especially when associated with ammonia, which can largely offset the cost of investment
 - For an HFC-134a/CO₂ system, HFC-134a can be used in the medium-temperature loop of indirect expansion systems in order to limit the refrigerant charge
 - The environmental impact of refrigerants use is low: CO₂, ammonia. Results coming from surveys have shown that in 2013, some operators proposed installation designs **anticipating retrofit from HFC-134a to R-1234yf** on new installations of the type HFC-134a/CO₂ cascade system.

Retrofit

In terms of retrofit, R-407F (GWP = 2060) is available as R-404A replacement option in low-temperature direct expansion systems; its efficiencies are better than R-407A at low temperature. However, most of the time, this retrofit is accompanied with performance decrease [ZOU13].

Alternatives to medium-temperature systems with flooded evaporators

New installations

Only pure refrigerants can be used in flooded evaporators. If ammonia cannot be used, CO₂ or MPG or potassium formate solutions can be used as heat transfer fluids.

Retrofit

Similarly to HCFC-22 replacement, R-404A retrofits are not possible presently for this type of installations. Their configuration requires the use of a quasi-azeotropic refrigerant and makes it impossible to use a refrigerant with a temperature glide higher than 1°C.

Alternatives to low-temperature systems with flooded evaporators

New installations

In low-temperature refrigeration systems, the situation is identical but CO₂/ammonia cascade type systems are also possible. These systems present also the disadvantage of high cost but excellent energy efficiency.

Alternatives under development: HFC/HFO blends with GWPs around 250

New refrigerant blends based on HFCs/HFOs are also under evaluation. These blends are designed for a direct replacement of R-404A. Among these blends, three are studied by Thermo King within the scope of the AREP/AHRI program [MAR13]:

- ARM-30a: HFC-32/R-1234yf (29/71)
- DR-7: HFC-32/R-1234yf (36/64)
- L-40: HFC-32/HFC-152a/R-1234yf/R-1234ze(E) (40/10/20/30)

FOOD PROCESSES - CONCLUSIONS

Available and interesting alternatives exist for medium-temperature or medium/low-temperature centralized direct expansion systems using R-404A, namely:

- 1) CO₂/ammonia "cascade" systems, when ammonia can be used from a regulatory point of view, that present excellent energy efficiency and quasi-nil environmental impact, but present disadvantages related to ammonia toxicity and flammability
- 2) CO₂/HFC-134a "cascade" systems, using HFC-134a in direct expansion system, which can be designed in view of retrofit to R-1234yf; in medium-temperature systems, if necessary, only HFC-134a indirect expansion systems that can be retrofitted with R-1234yf are also interesting from an environmental impact point of view. Cascade systems are particularly interesting because they compensate the HFC-134a lower energy efficiency and compensate for CO₂ poorer volumetric capacity of HFC-134a compared to R-404A. When safety conditions allow, ammonia can also be used instead of HFC-134a (see above)
- 3) retrofit opportunities exist with refrigerants having performances quite close to those of R-404A (in medium-temperature systems), which can be interesting in transitional period in order to bring the system to its end of life, at a reasonable cost (frequent for drop-in cases)
- 4) Most replacement refrigerants available or under development, are suitable for HCFC-22 that still covers about 15% of the food-process sector bank in France

5.6 AIR-TO-AIR CONDITIONING

Equipments of air conditioning can be structured in two sub-sectors, distinguished by their cooling capacity levels: the residential air-conditioning (< 17.5 kW) and commercial air conditioning. Factsheets follow this classification and that of refrigerants (R-410A and R-407C) with their replacements. Table 5.12 presents 2010 and 2011 market data.

Table 5.12 Markets of air-to-air conditioning equipments

Markets	Residential air conditioning				Commercial air conditioning			
	Movable*	Windows	Split systems	Multi-split systems	Vertical cabinets	VRV	Splits and Multi-split	Roof tops
2010	70,000	3,722	278,589	100,130	521	13,923	4,020	1,320
2011	70,000	3,648	267,215	93,614	565	15,500	4,185	2,500

* market data with high uncertainty. 2009 and 2010 corrected values.

Table 5.13 Refrigerants on the new market of air-to-air conditioning in 2011.

Refrigerants	2010	2011
Movable	100% R-410A	100% R-410A
Windows	100% R-410A	100% R-410A
Mono splits	2% R-407C, 98% R-410A	1% R-407C, 99% R-410A
Multi-split	14% R-407C, 86% R-410A	2% R-407C, 98% R-410A
Vertical cabinets	26% R-407C, 55% R-410A. 19% HFC-134a	20% R-407C, 62% R-410A . 18% HFC-134a
VRV	25% R-407C, 57% R-410A. 18% HFC-134a	20% R-407C, 62% R-410A . 18% HFC-134a
Splits and Multi-split	3% R-407C, 97% R-410A	0.5% R-407C, 0.5% HFC-134a 99% R-410A
Roof tops	27% R-407C, 73% R-410A	20% R-407C, 80% R-410A

Table 5.13 shows the R-410A domination in all sub-sectors of air-to-air conditioning, as explained in Section 4 (Table 4-6) and in factsheets. Refrigerants candidate to R-410A replacement are so HFC-32 with a volumetric capacity 12% higher and a GWP of 716; refrigerant manufacturers propose blends all containing about 70% of HFC-32 and so with a GWP in the range of 500, other components being essentially R-1234yf or R-1234ze (see Section 4.7).

5.7 RESIDENTIAL HEAT PUMPS (HPs)

Heat pumps (HPs) can be grouped in three families:

- **Ground source** heat pumps draw heat from the ground or from groundwater by means of a heat-exchanger network or boreholes
- **Air** heat pumps that draw heat directly from ambient air
- Thermodynamic domestic hot water heaters (DHW HP in Table 5-4) which the recent development is due to the implementation of the French thermal building regulation 2012 (TR 2012) and that represents already several tens of thousands units

Air-to-air and air-to-water HPs constitute air models. Ground-to-ground, ground-to-water, water-to-water, and MPG-to-water constitute ground source HPs (in the denominations, the first term indicates the origin of the source, the second the heat distribution mode). For MPG-to-water HPs, the heat is drawn from the ground via underground tubes where MPG circulates.

From a technological point of view, one has to distinguish air-to-air HPs that are very similar to air-conditioning split systems and HPs producing heat via a water network; in one case, the refrigerant is inevitably circulating in the room and safety rules (EN-378) define maximum quantities limiting charge of flammable or moderately flammable refrigerants whereas for HPs producing heat via water network, the thermodynamic system can be outdoor and only the MPG network transfers heat indoor.

Table 5.14 Market of residential HPs.

HPs	2010	2011
Air-to-water	53,854	55,299
Water-to-water	6,658	5,926
Ground-to-ground	1,548	1,312
Ground-to-water	751	553
DHW HP	-	26,000

The market (except DHW HP) stabilized around 60,000 units per year after reaching up to 150,000 units per year when HPs were eligible to tax credit.

Table 5.15 Refrigerants used for the new market of residential HPs in 2010 and 2011.

Refrigerants used	R-410A	R-407C	HFC-134a	R-417A
2010	85%	8%	5%	2%
2011	90%	5%	5%	-

Here again, as for air-to-air conditioning, the R-410A domination is obvious and technical options for refrigerants are identical: HFC-32 and HFC/HFO blends based on HFC-32 (see Table 4-6). This applies also to thermodynamic water heaters.

For industrial heat pumps, depending on temperature levels, refrigerant candidates for the future are R-1234ze and R-1233zd. Critical temperatures of these two refrigerants are respectively 109.4°C and 165.6°C, which allow specialized industries to propose heat pumps with higher temperature levels, provided that lubrication issues are properly addressed.

5.8 CHILLERS

Table 5.16 presents the consolidation of chillers for the three ranges of cooling capacities considered in report on refrigerant inventories [BAR12].

Table 5.16 Evolution of chiller markets from 2000 to 2010 and 2011 data.

Markets (unit number)	2000	2005	2010	2011
P < 50 kW	3440	9710	3220	2890
50 < P < 350 kW	4910	2950	3350	3390
P > 350 kW	1480	850	820	1000
<i>Of which centrifugal chillers</i>	49	53	56	56

As shown in Table 5-17, the choice of refrigerants is more varied for volumetric chillers that cover all ranges of cooling capacities.

Table 5.17 Refrigerants used on the new market of chillers in 2010 and 2011.

Refrigerants used	2010	2011
P < 50 kW	R-407C (31%) R-410A (69%)	R-407C (27%) R-410A (73%)
50 < P < 350 kW	R-407C (45%) R-410A (53%) R-717 (2%)	R-407C (53%) R-410A (45%) R-717 (2%)
P > 350 kW	R-407C (22,5%) R-410A (25,5%) HFC-134a (50%) R-717 (2%)	R-407C (22%) R-410A (26%) HFC-134a (50%) R-717 (2%)
Centrifugal compressors	HFC-134a (100%)	HFC-134a (100%)

A significant part of **these medium and small capacities chillers operates with R-407C** (HFC-32/125/134a 23/25/52). Replacement refrigerants are similar to that indicated for HCFC-22 (see Table 4.8), which are HFC-32-based refrigerant blends with concentrations lower where, in fact, HFC-125 and HFC-134a are replaced by R1234yf and/or R-1234ze with **GWPs in the range of 300** because HFC-32 concentration remains at or below 40%.

For chillers operating with R410A, refrigerant candidates are similar with HFC-32 contents around 70% and GWPs around 500.

To be mentioned that since chillers can be compact and installed outdoor, it is possible **to use ammonia** from a cooling capacity typically higher than 250 kW_{cooling capacity} to compensate additional costs due to heat exchangers. It is also possible **to use propane R-290**, which is proposed by some European companies.

For cooling capacities > 350 kW, **centrifugal chillers** and some with screw compressors operate with HFC-134a. Pour centrifugal chillers, tests are advanced enough and R-1234ze seems to be the reference refrigerant for the future.

5.9 MOBILE AIR CONDITIONING

The mobile air-conditioning sector is divided in three sub-sectors, determined by the technologies in use.

- Mobile air conditioning includes circuits of cars and light vehicles up to 5 t
- Industrial vehicles (IV) grouping trucks and farm tractors. This sub-sector is close to that of air conditioning. Only the driver cabin is cooled, via systems of similar technology. Buses and coaches present different air-conditioning systems, more powerful, where the entire vehicle is air conditioned.
- Trains, tramways, subways and RER, technologies come from stationary air conditioning and refrigerants are either HFC-134a or R-407C.

Table 5.18 New registrations of vehicles.

MARKETS	Cars and vans up to 5 t	Industrial vehicles (IV)	Buses and coaches
2010	2,669,281	41,773	5,382
2011	2,633,483	47,363	6,206

- For cars and coaches, and also for trucks or farm-tractor cabins, only HFC-134a is used
- Air conditioning systems for trains use HFC-134a or R-407C, depending on whether they are mounted on TGVs in TERs and driving cabins [PAS12].

Table 5.19 Average charges

Charges (kg)	Mobile air-conditioning	Industrial Vehicles	Buses and coaches	Trains
2010	0.54	0.77	12.1	10.9
2011	0.52	0.76	11.5	10.6

R-1234yf has been chosen to replace HFC-134a, after lengthy comparative studies carried out on test benches and vehicle installed bases, for all components. International working groups have met on behalf of SAE and have analyzed thoroughly risks associated to the very moderate flammability of this refrigerant. The competition between R-1234yf and CO₂ has been very bitter from 2006 to 2010. CO₂ did not appear as a global option with a system cost higher of at least a factor 2 to 2.5 compared to systems using R1234yf, and that due to CO₂ high pressure. In Europe the controversy of 2013 on the R-1234yf flammability aims at the extension of HFC-134a use.

For R-407C, as previously said (see Table 4-8), replacement refrigerants are blends with HFC-32 content up to 40% and with GWP around 300.

6. DATA ON TECHNOLOGIES ALTERNATIVE TO COMPRESSION SYSTEMS CONTAINING HIGH-GWP HFCs

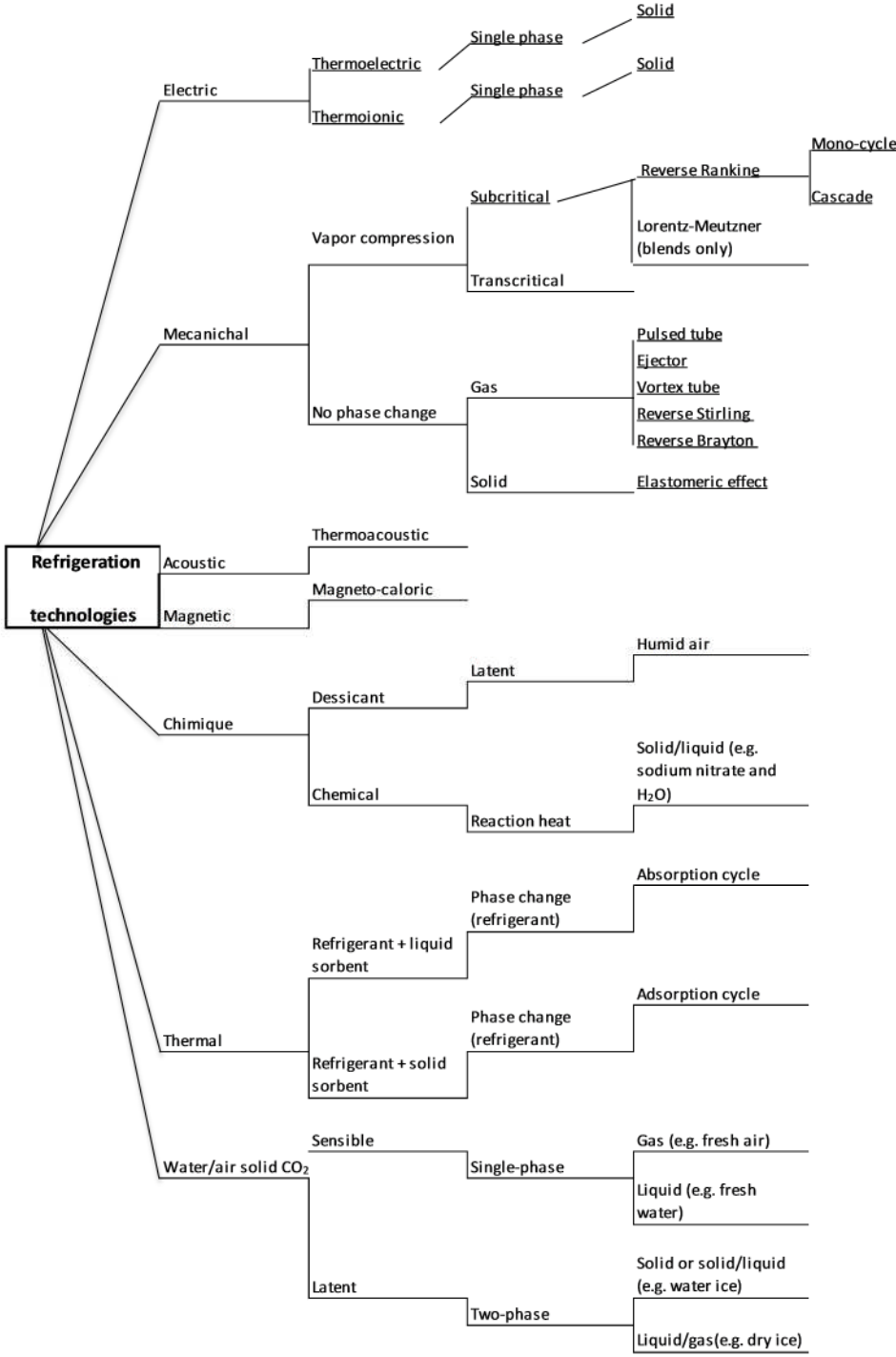

Figure 6.1 Structuration by physical principle of refrigeration systems (Brown 2011).

As shown on Figure 6.1, refrigeration production can be made by electric, mechanical, magnetic, chemical, and thermal retrofit processes. This variety led to niche developments for certain technologies, but one technology covers massively almost all applications: vapor compression of refrigerants with phase change. Phase change is also present in absorption adsorption processes and solid-liquid or solid-vapor cooling delivery. Technologies that are already in application or that are under significant research programs are described in next sections.

Ref. J.S. Brown, P.A. Domanski. *Alternative cooling technology options. ICR 2011, August 21-26, Prague, Czech Republic.*

6.1.1 Absorption refrigeration equipment

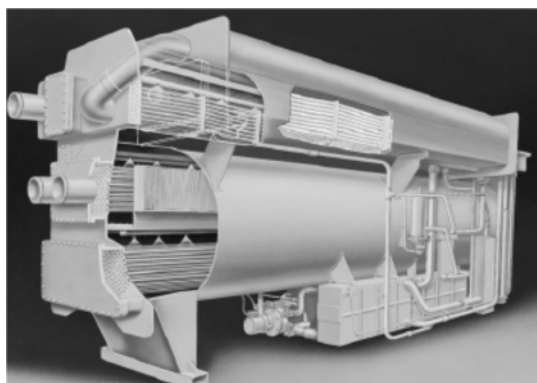

Figure 6.2 LiBr-absorption equipment (Trane).

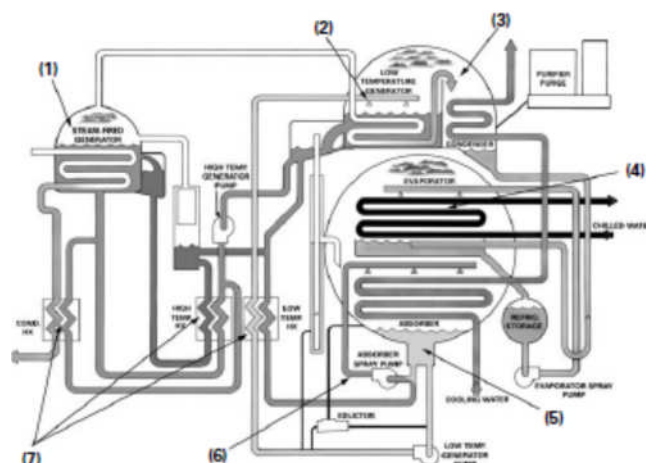

Figure 6.3 Principle lay-out of a double-effect equipment (Trane).

Absorption equipments exist since the invention of refrigeration equipments (around 1850). Absorption preceded compression systems. Both pairs, refrigerant and absorbent, which have dominated and still dominate the market of absorption equipments are:

- Water as refrigerant and water-lithium bromide solution as absorbent
- Ammonia as refrigerant and the water-ammonia solution as absorbent.

Water–Lithium bromide

Water-lithium bromide absorption chillers are, in general, equipment with cooling capacities higher than 350 kW and up to several megawatts (see Figure 6.2). The sole exceptions are equipment manufactured by the YASAKI group of which equipment starts around 50 kW cooling capacity. Water-lithium bromide equipments evaporate water at 2°C and operate under partial pressure (7 mbar), which implies very large volumes because of the vapor steam density at 2°C, which is of 5 g/m³.

As mentioned in Trane documents, that manufacture absorption and compression chillers, absorption represents in the range of 0.5% of the global market of large-capacity chillers.

Table 6.1 Sales of water-lithium bromide absorption equipment in China (Chen 07).

Year	1996	1997	1998	1999	2000	2001	2002	2003	2004	2005
Direct-fired type	1230	1341	1529	1352	2091	2385	3052	2785	4200	5600
Total	3249	3575	2780	2600	3289	3845	4320	3838	5500	6917

As shown in Table 6.1, China as well as Japan and Korea, manufacture and use a installed base of several tens of thousands of these chillers ; most of them are gas-fired (direct-fired in Table 6.1) others operate with steam as heat source. The coefficient of performance (COP) of such units, for evaporation temperature of 2°C and condensation of 35°C, varies between 1 and 1.2. For these three countries, absorption machines allow air conditioning via direct use of the gas network or industrial utilities and not the electrical network during peak hours. Japan, in the 80s, made a significant work to improve energy efficiency of these equipments with double effect, raising the COP from 0.7 to 1.1. This requires 11 heat exchangers and the boiler operates around 170°C. With these energy efficiencies performances, the asymptote is quasi reached with water-lithium bromide because triple effect equipment requires 17 heat exchangers and the maximum temperature is in the range of 225°C and COP around 1.4.

Ammonia - Water

For water-ammonia systems, a specific implementation exists, said absorption-diffusion – water + ammonia + hydrogen pressurization for domestic refrigerators used in hotels (to limit the noise), camping (12 or 14-V operation) and possible operation with gas burner. The market remains nearly constant, around 1 million units per year, and Electrolux remains a reference brand for this niche application, which has to be compared to 110 million compression refrigerators sold in the world in 2012. These refrigerators cannot compete on the general market of domestic refrigeration due to their low energy efficiency.



Figure 6.4 Water-ammonia absorption-diffusion 31-L refrigerator.

From the SERVEL technology of the 70s, Robur has developed water-ammonia absorption air-conditioners that can also operate as heat pumps; the market is in the range of 50 to 100 equipments per year. The refrigeration COP is in the range of 0.7. The German engineering Borsig, which was specialized in water-ammonia of large refrigeration capacities (several MWs) to produce cold, including at -40°C , does not put these equipments in its catalog any longer.

From the energy point of view, it has to be emphasized that two technical options exist:

- recovery/transformation of waste heat
- solar refrigeration.

This last option is slowly restarting and start-ups are being created in Europe aiming at its development. Absorption machines are dominant (70%) ; the global market is estimated at 700 machines/year (BOU13).

Manufacturers of water-lithium bromide equipment: about twenty Chinese companies, TRANE, CARRIER, YORK, EBARA, HITACHI, KAWASAKI, HUNDAI...

Manufacturers of water-ammonia equipment: Electrolux and some competitors for small mini-bar refrigerators and camping; Robur for air conditioning / heat pump.

Costs of these equipments being higher, their development is in niches.

References

Guangming Chen, Yijian HE. 2007. The latest progress of absorption refrigeration in China. International Congress of Refrigeration, Beijing, China. Paper ICR07-b2-174.

Trane Horizon Absorption Series. 2001. Two-stage steam-fired or hot water absorption water chillers. Documentation commercial ABS-PRC004-EN.

B. Thonon. European project EIE/06/072 / S12.444283. Promotion of efficient heat pumps for heatings (ProHeatPump). Report on renewables and heat pumps. WP 5, Deliverable n° 19.

6.1.2 Adsorption refrigeration equipment

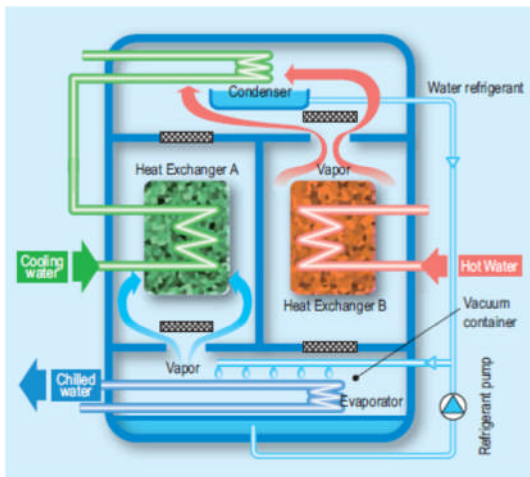

Figure 6.5 Adsorption system principle (Mycom).



Figure 6.6 MYCOM adsorption machine.

Adsorption equipments are bound up with solar energy or waste heat recovery because energy efficiency (ratio of the refrigeration capacity to the thermal capacity provided) is low, in the range of 0.6, but its interest is to valorize heat at a low temperature level, from 70 to 80°C. As shown on Figure 6.5, the system includes a solid matrix that can be either silica aerogel or a zeolite. This solid matrix absorbs vapor when it is cooled and desorbs the vapor trapped in the solid matrix when it is heated. This simple description indicates the significant energy loss when it is necessary to cool the matrix that was just heated. One of the possible improvements would be to operate the adsorption system with at least 4 heat exchangers and not 2 to recover part of heating and cooling energies. Figure 6.6 shows the massif aspect of these installations that operate under vacuum since they evaporate water.

The Mayekawau (Mycom) brand presents the variation of performances (see Figure 6.7) and also characteristics of equipments: an equipment producing 100 kW_{cooling capacity} at 15°C and 17 mbar, uses heat at 68°C but needs 50m³/h of water at the condenser to release heat at 27°C and weighs 6.6 tons!

At 200 kW, 10 t and at 430 kW, 25 t.

So a lot of waste heat at 70°C is necessary to valorize such an investment.

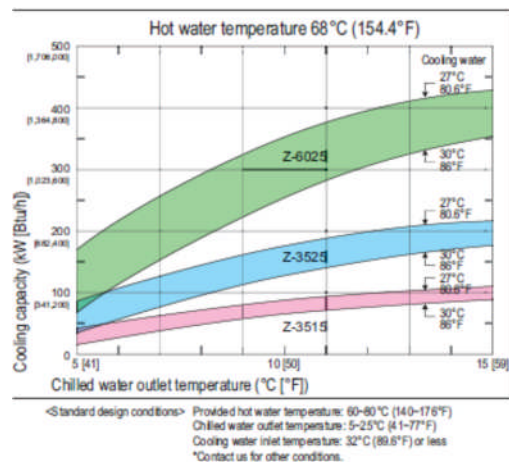

Figure 6.7 Variation of the refrigeration capacity as a function of temperature (Mycom).

Manufacturers of such equipments are: MAYEKAWA, Weatherite, and start-ups such as SORTECH

Uses are:

- solar refrigeration
- low-temperature waste heat recovery

Costs of components are high because:

- operation in depression implies significant thickness due to large necessary volumes

- the significant mass of silica aerogel or zeolite because the order of magnitude of single-stage operation is 1 kg of zeolite to absorb 50 g of steam ; it can be as high as 100 g of steam/kg of adsorbent for two-stage systems

The current global market is in the range of **60 to 80 machines / year**.

References

F. Boudéhenn. 2014. Etat des lieux de la climatisation solaire. Rassemblement CQP – Juin 2014.

S. Jribi, I.I. El-Sharkawy, S. Koyama, B.B. Saha. 2010. Study on activated carbon-CO₂ pair : adsorption characteristics and cycle performance. International Symposium on Next-generation Air Conditioning and Refrigeration Tehchnology, 17-19 February 2010, Tokyo, Japan.

MAS Uyun, T. Miyazaki, Y. Ueda and A. Akisawa. 2010. Numerical Analysis of Double Effect Adsorption Refrigeration Cycle Using Silica-Gel/Water Working Pair. International Symposium on Next-generation Air Conditioning and Refrigeration Tehchnology, 17-19 February 2010, Tokyo, Japan.

E.E. Vasilescu, R. Boussehain, M. Feidt, A. Dobrovicescu. 2008. Analyse exergétique comparative des systèmes frigorifiques à adsorption à un ou deux étages à simple ou double effet. Termotehnica 2/2008.

AdRef-Noa. Adsorption chiller with zeolite. Commercial documentation Mycom.

6.1.3 Brayton cycle refrigeration equipment

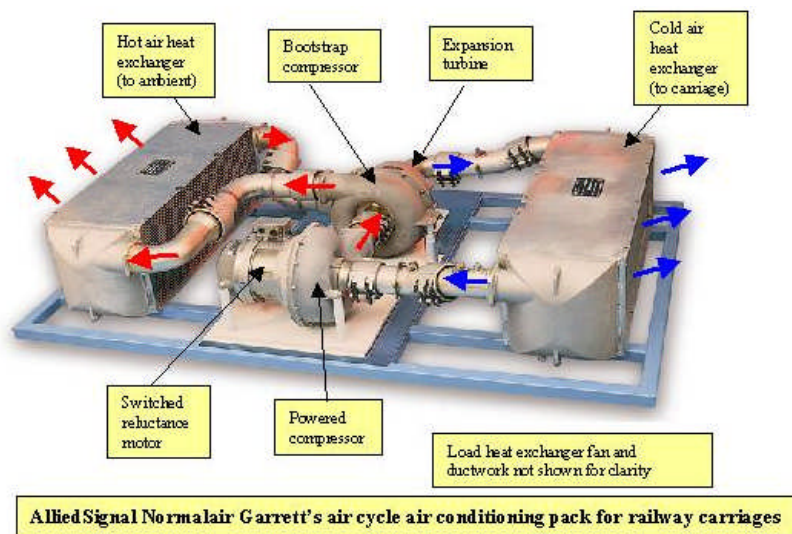

Figure 6.8 Brayton system for train air-conditioning (Garrett).

Air-conditioning systems based on the air Brayton-Joule cycle are systems developed for civil aviation since the 50s. These systems are integrated in the management system of pressurization, temperature and hygrometry of the cabin. Essential points are the lightweight of the turbo-compression system and not the energy efficiency. Brayton systems exist for cryogenic cycles for methane liquefaction low flow rates ($< 2000 \text{ Nm}^3/\text{h}$ of methane) and for space applications at -200°C .

Manufacturers of these equipments for aviation, such as Garrett or Liebherr, have developed as soon as the end of the '90s such systems for air-conditioning of ICE trains, with orders in the range of 100 units.

The Brayton air cycle is calculated very easily and its performances depend on source and sink temperatures as any thermodynamic system and also efficiencies of compressors and turbines.

As shown on Figure 6.9, indicating the energy efficiency for turbine an compressor efficiencies of 0.9, for a temperature difference of only 12°C , which is a pressure ratio of 2, the COP is 1.5, and above all this COP decreases significantly with the increase of the pressure ratio, which is directly related to the increase in the source/sink temperature difference.

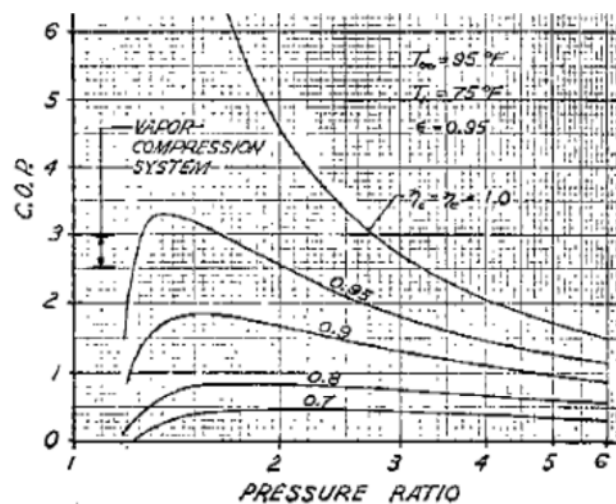

Figure 6.9 Variation of the refrigeration capacity as a function of temperature (Scott).

Manufacturers of these equipments are: Garrett, Liebherr for aviation and ICE trains, and Air Liquide and its competitors for low temperatures.

Usual usages are: Les usages habituels sont :

- airplane air-conditioning
- cryogenic applications of some tens of W

Costs of components are a priori of the same order of magnitude as for train air-conditioning systems.

Potential markets: the generalization of the technology for train air-conditioning is not verified.

References

Liebherr-Aerospace & Transportation SAS. 2011. Air Cycle Air Conditioning Technology On Board the ICE 3. Documentation.

S. Engelking, H. Kruse. 1996. Development of Air Cycle Technology for Transport refrigeration. International Refrigeration and Air Conditioning Conference at Purdue. Paper 348.

A. Gigiel, T. Brown, D. Holder, and P. Fitt. 1995. Cycles à air pour les systèmes frigorifiques et les pompes à chaleur. IIF/IIR Bulletin 95-4.

T.C. Scott, G.L. Davis. 1976. Thermodynamics of Air/Water-Cycle Air-Conditioning Systems. International Compressor Engineering Conference at Purdue University. Paper 229.

6.1.4 Stirling refrigeration equipment



Figure 6.10 Stirling Coleman system cooler.



Figure 6.11 Stirling module by Twinbird.

One of the first refrigeration equipment has been developed by Philips in 1950. Then, applications were directed towards low temperatures, Stirling systems being particularly well-suited for large temperature differences between source and sink. Stirling Cryogenics company commercialized more than 3000 of these low-temperature systems (from -80°C to -200°C) for refrigerating capacities from some tens of kW to some thousand.

For refrigeration applications, the free-piston system developed by Sunpower in the '70s, with capacities varying from 35 W to 7.5 kW. Since 2002, the Japanese company Twinbird commercializes various modules (see Figure 6.11). These modules can be integrated for example in portable coolers (see Figure 6.10). Stirling modules have been developed preferably for capacities of few hundred watts, one of the limitations being the reduced areas of hot and cold ends of Stirling systems. These reduced sizes are intrinsic to the process.

Refrigeration capacities obtained vary from **some tens of W to almost 10 kW** for “classical” refrigeration applications. For cryogenic coolers from -80 to -200°C , refrigerating capacities can reach several megawatts.

For 100°C of temperature difference between the cold source and the hot sink with a refrigeration production of -80°C , the COP is about 0.3 and for -20°C temperature, the COP is about 0.6, which is lower than vapor compression cycles. .

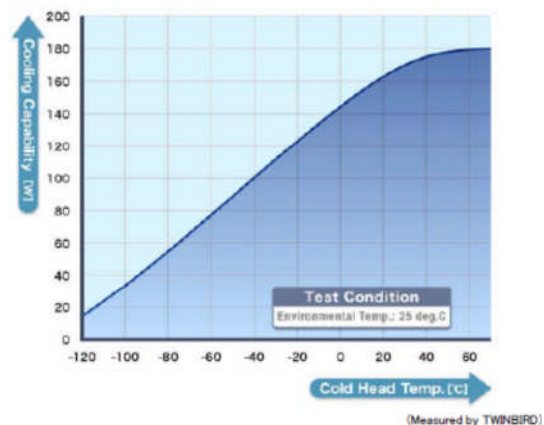

Figure 6.12 Refrigeration capacity variation as a function of temperature (Twinbird).

Manufacturers of these equipments are: Twinbird, Sunpower, Stirling Cryogenics

Usual usages are:

- medical, industrial, biology cryogenic applications ...
- refrigeration applications: portable coolers

Costs of components are rather high because the operation is at high pressure with noble materials.

Potential markets: small commercial refrigeration

References

D.M. Berchowitz. 1992. Free-Piston Stirling Coolers. International Refrigeration and Air Conditioning Conference at Purdue University. Paper 171.

M.J. Fabien. 1991. Evaluation of the free-piston Stirling cycle for domestic cooling applications. XVIII International Congress of Refrigeration, Montreal, Québec, Canada. 10-17 August 1991.

FPSC. SC-UE15 150W Type FPSC Module. http://fpsc.twinbird.jp/legacy/en/sc_ue15_mod_e.html. 2013/08/09.

Coleman Stirling Power Cooler. <http://coleman.com/product> 2013/08/09.

6.1.5 Refrigeration equipment with pulsed tube



Figure 6.13 Pulsed tube (Sumitomo).

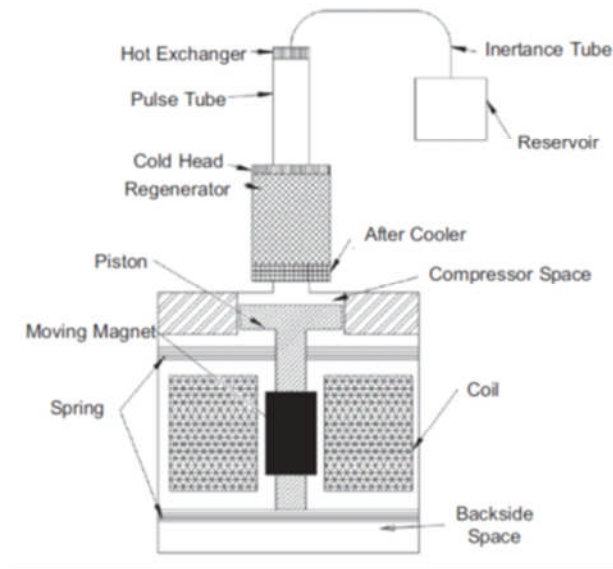

Figure 6.14 Cut of a Stirling type pulsed tube (X. Wang et al).

Cryogenic pulsed tubes constitute a mature technology since the beginning of the '90s where energy efficiencies joined those of Stirling cryogenic systems. It can be considered that pulsed tubes constitute at least 50% of the current market of cryostats or cryogenic refrigerators which temperatures are in the range of -200°C and down to -270°C .

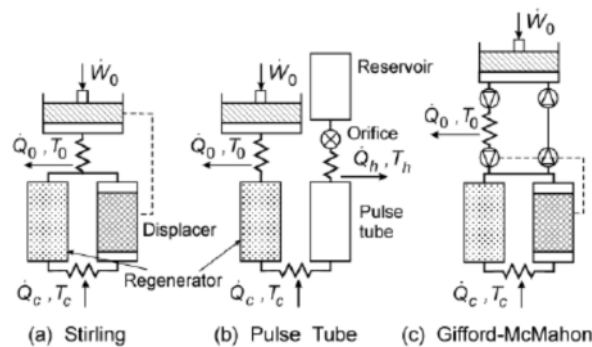

Figure 6.15 Comparative analysis of three cryogenic systems that share the cryostat market (excerpt from R. Radebaugh 00).

The principle of the pulsed tube with orifice is explained simply enough by comparison to Stirling and Gifford Mac Mahon systems (Figure 6.15). The simple volume of the pulsed tube replaces the displacer of other systems. The oscillating gas flow rate goes through the orifice downstream the tube and upstream of a reservoir. This set composed of the pulsed tube volume, the orifice and the reservoir has the same effect as the displacer of the two other systems, namely separating the hot end and the cold end. The cycle is as follows:

- 1 Helium compression in the pulsed tube
- 2 Flowing of the compressed gas through the orifice and release of the heat at the hot end upstream the orifice

- 3 Suction of helium and expansion of helium in the pulsed tube
- 4 Transfer of the cold gas to the cold end (downstream the regenerator) via the overpressure from the reservoir

Refrigerating capacities vary from 1 to 100 kW at temperatures in the range of -200°C.

COPs referred to Carnot are in the range of 5 to 10%.

Accessible temperature differences vary from 220 to 280 K.

Manufacturers of such equipments are: Cold Edge, Sumitomo, Cryomech, Air Liquide, Linde, Thales Aerospace

Markets are as follows:

- cryostats for cryo-pumps necessary to the manufacturing of semi-conductors, which means a market of 20,000 cryostats/year still dominated by Cryostat Gifford - McMahon
- applications for satellite observations, 500 to 1000 cryostats per year, capacity 1 à 2 W
- medical applications
- natural gas liquefaction (demonstration under preparation)

Costs of equipments are between 30 k€ and 80 k€ depending on refrigerating capacities.

References

X. Wang, W. Dai, J. Hu, E. Luo, and L. Zhou. 2011. Performance of a Stirling-type pulse tube cooler for high efficiency operation at 100 Hz. . International Cryocooler Conference Inc. Boulder CO. USA.

D.R. Brown, J.A. Dirks, N. Fernandez, T.B. Stout. 2010. The Prospects of Alternatives to Vapor Compression Technology for Space Cooling and Food Refrigeration Applications. Report prepared for the US DOE. Ref. PNNL-19259.

J.S. Brown and P.A. Domanski. 2011. Alternative cooling technology options. ICR 2011, August 21-26, Prague, Czech Republic. ID: 214.

P. Duthil. 2007. Un réfrigérateur sonore. IPN Science n° 11, p. 26-30. Novembre 2007.

W.E. Gifford and R.C. Longworth. Pulse Tube Refrigeration Progress. Adv. in Cryogenic Engineering, Vol. 10, Plenum Publishing Corp., New York (1965), pp. 69-79.

R. Radebaugh. 2000. Development of the Pulse Tube Refrigerator as an Efficient and Reliable Cryocooler. NIST.

S. Rotundo, G. Hughel, A. Rebarchak, Y. Lin, B. Farouk. 2007. Cryocoolers 14, edited by S.D. Miller and R.G. Ross, Jr. International Cryocooler Conference Inc. Boulder CO. USA.

6.1.6 Thermo-acoustic refrigeration equipment

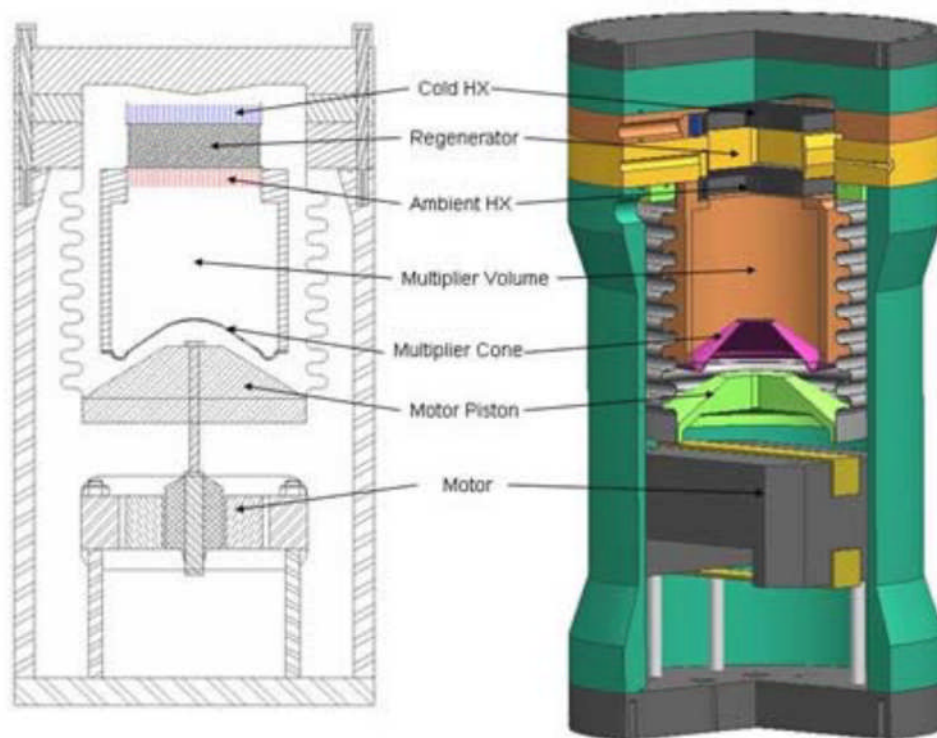

Figure 6.16 thermo-acoustic freezer, Ben & Jerry's (Pen State university).

Thermo-acoustic refrigeration consists in organizing the heat transfer of a fluid in acoustic resonance (heating at the gas compression by the acoustic wave, cooling during expansion) towards an insulating solid structure (Figure 6.16: regenerator and Figure 6.17: wall). This transfer creates a thermal gradient which, in turn generates a hot end (Figure 6.16; ambient Hx) and a cold end (cold Hx).

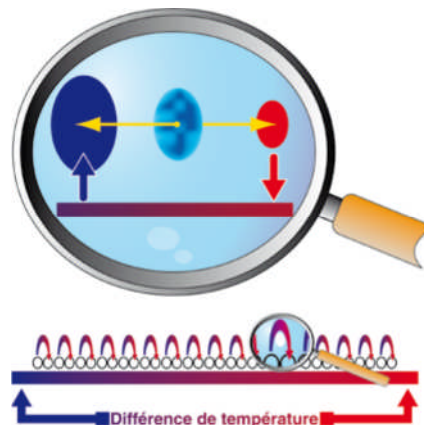

Figure 6.17 Principle of the gas compression/expansion by the thermo-acoustic wave and exchange with the wall (P. Duthil).

The system consumes acoustic energy generated by the acoustic resonator moved electrically and develops a cycle that is close of the Stirling cycle, which is two isochore evolutions (one expansion, the other compression) and two evolutions of heat transfer said "isothermal". Isothermal evolutions are ideal and heat transfers take place with temperature differences.

The thermo-acoustic effect has been known since the 19th century but the practical thermo-acoustic started only as of 1960, by calculations performed by N. ROTT and are also linked to developments on the pulsed tubes that, in fact, take place at lower frequency. But continuous developments are on-going at Penn State University, directed by S. Garrett. In 2003, this team realized a demonstrator freezer "Ben's & Jerry" which performances are analyzed in Table 6.2 by comparison with two prototypes, one for the STAR space (1992) and TALSAR (1991).

Table 6.2 Performances of thermo-acoustic systems (source G. Pénelet 2010).

	S.T.A.R.	T.A.L.S.R	« Ben & Jerry's » Fridge
ΔT (K)	<80	<50	<50
Q_c (W)	<5	260	120
COPR (%)	20	40	19
Working Fluid	97% He, 3% Ar 10 Atm. (1 MPa)	89% He, 11% Xe 20 Atm.	He 10 Atm.

As it can be seen:

- refrigeration capacities of demonstrators are from some tens to some hundreds of watts
- COPs referred to Carnot are in the range of 20% and can raise up to 40%
- Accessible temperature differences by prototypes are from 50 to 80°C.

Manufacturers of these equipments are R&D companies (Hekyom in France) or laboratories (LAUM).

Demonstrations have been made in about fifteen laboratories worldwide.

Potential uses are: small commercial refrigeration, but also large-size systems for natural gas liquefaction.

Costs of components are: rather “high-tech” side

Estimation of potential markets is power generation by the thermo-acoustic cycle by waste heat recovery and power generation on-board of satellites.

References

G. Pénelet. 2010. Introduction à la thermoacoustique. Journées thématiques « Machines thermoacoustiques : contribution au développemet durable ». Paris, 10 décembre 2010.

P. Duthil. 2007. Un réfrigérateur sonore. IPN Science 11 (2007) 26-30.

G. Poignand. 2006. Réfrigérateur thermo-acoustique : Etude du système compact et du comportement transitoire. Thèse de doctorat de l'Université du Maine, Le Mans, France.

I. Paek, J.E. Braun, L. Mongeau. 2006. Evaluation of thermoacoustic cycles for cooling applications. International Refrigeration and Air Conditioning Conference at Purdue, July 17-20, 2006. R130.

M.E. Poese and S.L. Garrett. 1998. Performance measurements on a thermoacoustic refrigerator driven at high amplitude. The Pennsylvania State University. Technical Report no. TR98-003.

R. Starr, P.K. Bansal, R.W. Jones, B.R. Mace. 1996. The Reality of a Small Household Thermoacoustic Refrigerator. International Refrigeration and Air Conditioning Conference at Purdue, 1996. Paper 344.

6.1.7 Magneto-caloric refrigeration equipment

The magneto-caloric effect (MCE) is an effect associated to the exposure, then the withdrawal of a magnetic material in a magnetic field. This effect has been evidence in 1881 by Warburg. This brief description implies that the magnetic material moves alternately in and out of the magnetic field, which is possible with slurries including magnetic materials in suspension, which means that the magnet, preferably permanent, changes its position alternately. Such rotary devices exist.

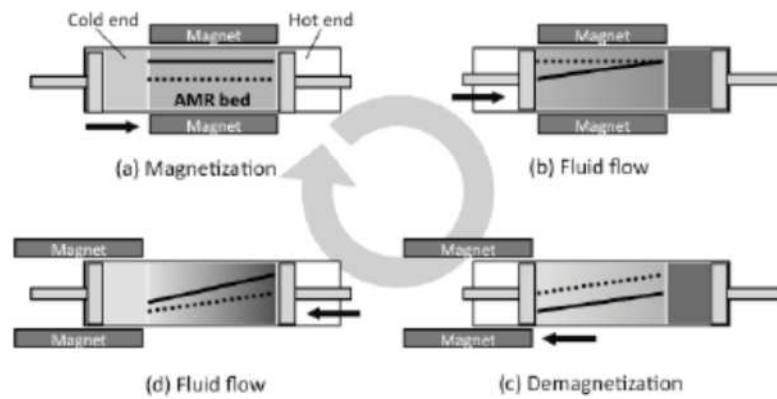

Figure 6.18 : Magnetic refrigeration principle (Kawanami 2010).

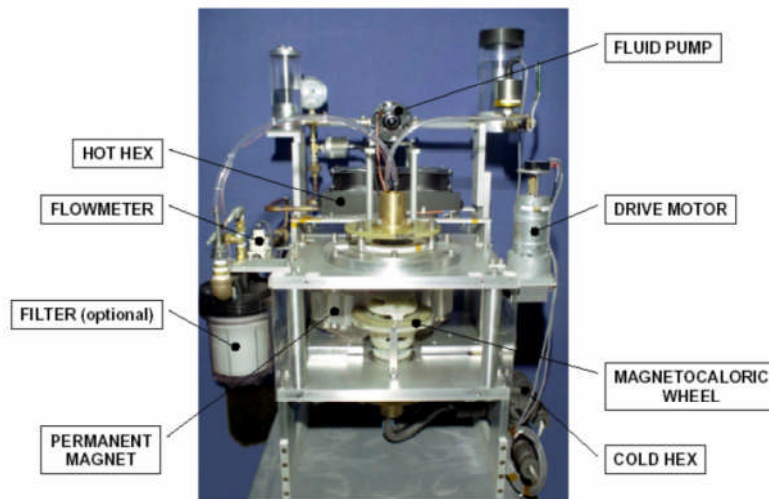

Figure 6.19 : Principe du froid magnétique (Astronautics Corporation of America)

Figure 6.18 shows the operation cycle which is an alternate heat transfer cycle (exothermal and then endothermal) by being **in** then **out** of the magnetic field and Figure 6.19 shows one of the first prototypes.

The magnetic material chosen for operation at temperatures close to ambience is the gadolinium or alloys of this material.

It should be mentioned that magnetic fields of at least 2 Tesla are required with permanent magnets to obtain significant results. To reach such magnetic intensities, the quality of materials and the use of rare earths is essential, which leads inevitably to an analysis of the life cycle of materials used. It is the same for gadolinium, which is a rare earth. Researches on materials focus precisely on the replacement of gadolinium by other alloys. The coefficient of performance is very sensitive to temperature variations that are related to both the Curie point of the material and the variation of magnetic susceptibility of the material depending on the temperature.

The refrigerating capacity reached up to now is about 1 kW.

The input power is of 800 W to produce this kW, for 12°C temperature difference between source and sink, according to data published by Engelbrecht.

The COP is 1.2 as measured. COPs foreseen, taking into account all auxiliaries, are in the same order of magnitude as that of vapor compression systems.

The French company Cooltech, created in 2003, just did a fundraising of € 8 million for the development of magnetic refrigeration and claims a staff of 30 people. So far, no functional prototype was presented. On the scale TRL (Technology Readiness Level), which has nine levels, TRL 1 being the proof of concept and basic TRL 9 industrialization, magnetic refrigeration is a TRL 2 to 3.

R&D companies of such systems: Astronautics Corporation of America, Cooltech, Chudu Electric Power,...

Usual usages are: no industrial use exist currently.

Costs of components are high because of the nature of materials.

The potential application field is small commercial medium-temperature refrigeration.

References

- [Bou08] Houssef Rafik El-Hana BOUCHEKARA. Recherche sur les systèmes de réfrigération magnétique. Modélisation numérique, conception et optimisation. Thèse de Génie électrique, Institut Polytechnique de Grenoble. 2008
- [Dea84] D.D. DEARDORFF and D.L. Johnson. Magnetic Refrigeration Development. TDA Progress Report 42-78. April-June 1984.
- [Ego07] Peter W. EGOLF, Andrej Kitanowski, Didier Vuarnoz, Marc Diebold, Christophe Besson. An introduction to magnetic refrigeration. International Congress of Refrigeration, Beijing, 2007.
- [Eng06] Kurt L. ENGELBRECHT, Greg. F. Nellis, Sanford A. Klein. Predicting the performance of an active magnetic regenerator refrigerator used for space cooling and refrigeration. HVAC&R Research, Vol.12, no. 4, October 2006.
- [Iif07] Le froid magnétique à température ambiante. 20^{ème} Note d'information de l'IFF sur les technologies du froid. Bulletin IIF IIR 2007-5.
- [May11] Charlotte MAYER. Nouveaux matériaux magnéto-caloriques pour la réfrigération magnétique. Thèse en Physico-chimie de la matière condensée. Université Bordeaux 1. 2011
- [Row05] Andrew ROWE, Armando Tura, John Dikeos, and R. Chahine. Near room temperature magnetic refrigeration. Proceedings of the International Energy Conference – IGEC-1, Waterloo, Ontario, Canada, June 2005. Paper 084.

6.1.8 Thermo-electric (TE) refrigeration equipment

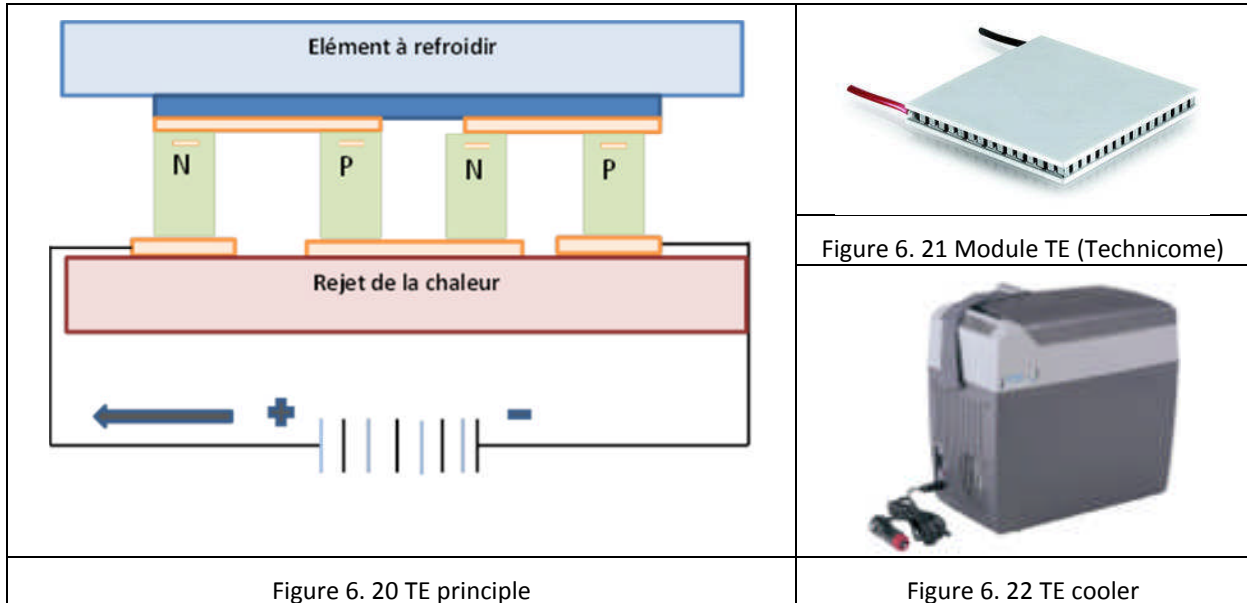

Thermo-electric refrigeration (Figure 6.20) is based on the principle of associating in series electrically couples P and N of semi-conductor materials, usually bismuth telluride (Bi_2Te_3). Type N material is boosted so as to obtain electrons in excess, while others of type P are boosted so as to be deficient in electrons. The heat flux is transferred by the electron flow so as the thermal cooling of the bond from P to N and the heat release from N to P associate TE modules thermally in parallel whereas they are in series electrically. Commercialized modules (see Figure 6.22) present **heat capacities, evaluated for a nil temperature difference**, which vary from 5 to 100 kW. The most usual cooling use of thermo-electric modules is the cooling of electronic components that have to be maintained at a given ambient temperature. The cooling capacity is low, at best a few hundred watts, and the energy efficiency decreases very rapidly with the temperature difference. This is the reason why commercialized equipment is for example 12/24 V electric coolers of 10 to 15-L capacity (see Figure 6.22), with typical refrigeration capacity of 20 W for a temperature difference of 20°C.

The essential characteristic of a thermo-electric material is defined by the factor of merit Z:

$$Z = \frac{\alpha^2}{\rho \lambda} T$$

With:

α : Seebeck coefficient (V/K)	ρ : electrical resistivity ($\Omega \cdot m$)	λ : heat conductivity (W/m.K)
--------------------------------------	--	---------------------------------------

The typical value of factors of merit is 1. Seebeck coefficients are in the range of 0.2 V/K; this confirms that energy levels are low. Moreover, coefficients of performance relatively to Carnot are in the range of 10 to 15% at the best while that of vapor compression standard systems are around 50%.

As shown on Figure 6.23, the heating capacity varies in a quasi-logarithmic way with the current and indicates a rapid saturation of the power increase. The most significant factor is the temperature difference, the lower it is, the more the power can be at equal circulating current.

Figure 6.24 shows COPs lower than 1.5 as soon as the temperature difference between hot and cold ends is 20°C. In addition, as presented on Figure 6.21, a small surface requires often the use of secondary liquid to transfer the energy to air for volumes of size larger than some liters.

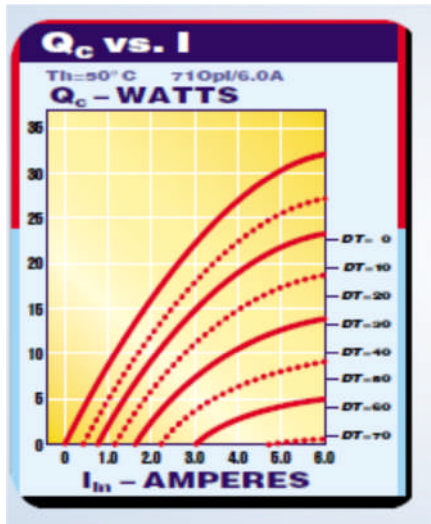

Figure 6.23 Heating capacity variation as a function of amperage and of the temperature difference (Otey et Moskowitz).

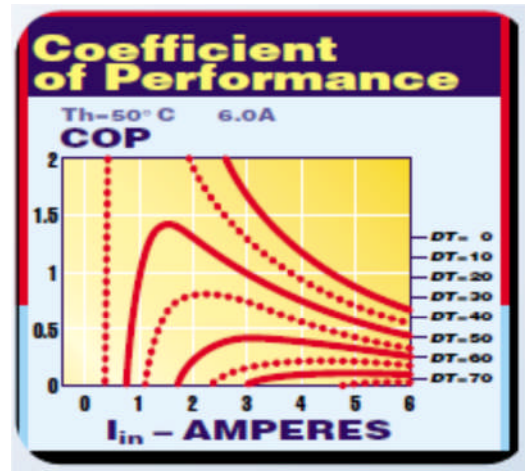

Figure 6.24 COP variation as a function of amperage and of the temperature difference (Otey et Moskowitz).

There are many manufacturers of modules: Ferrotec, Kryotherm, DBK, Laird Technologies, CUI Inc., Analog Technologies, Fisher Elektronik, Photonik product ...

They are either manufacturers of multi-application modules, or specialized in cooling of electronic components or laser sources.

There are manufacturers of coolers and small refrigerators (Samsung, but also Chinese manufacturers), which are niche applications.

The usual usage is the cooling of electronic components.

Costs of components are in the range of 10 to 20 € for a thermo-electric module capable to produce 10 W for 10°C of temperature difference.

Estimation of potential markets for refrigeration applications: niche market of portable coolers.

References

R. Otey and B. Moskowitz. 2001. Thermoelectric coolers offer efficient solid-state heat-management options. From OE Magazine March 2001.

J.G. Stockholm. Génération thermoélectrique. 2002. Energie portable : autonomie et intégration dans l'environnement humain. 21-22 mars 2002, Cachan. Journées Electrotechniques du Club EEA. ISBN 2-909968-10-3. P. 35-42.

J. Yu, B. Wang. 2009. Enhancing the maximum coefficient of performance of thermoelectric cooling modules using internally cascaded thermoelectric couples. International Journal of Refrigeration 32 (2009) 32-39. Elsevier.

Thermoélectricité. <http://fr.wikipedia.org/w/index.php?oldid=95860001>. Août 2013.

6.1.9 Dry ice systems and liquid nitrogen systems

For these systems, there is uncoupling between **the production** of the cold vector: dry ice or liquid nitrogen **and the use** of the refrigeration capacity. In both cases, in fact the use is cold storage without taking care of the incorporated energy to utilize the useful refrigeration capacity.

Dry ice

CO₂ presents a triple point at -56°C and 520 kPa, which makes it an exceptional substance. At atmospheric pressure, it sublimates at -78°C; its latent heat is about 580 kJ/kg, which is 175% higher than the fusion latent heat of water ice. As shown on Figure 6.25, dry ice is sold under various shapes depending on its use.



Figure 6.25 Various shapes of CO₂ dry ice (Messer).

All air transport in aircraft cargo is made by CO₂ sublimation either by natural convection or assisted ventilation



Figure 6.26 Dry ice pelletizer (Cold Jet).



Figure 6.27 Dry ice container (Linde).

As shown on Figure 6.26, either one can produce its own dry ice by CO₂ bottle expansion, or by delivery of dry ice containers (Figure 3.27). Industrial CO₂ comes mainly from the production process of ammonia (Haber-Bosch process) where 4 molecules of CO₂ are formed for one molecule of ammonia. Raw materials for the method are methane and nitrogen. The produced CO₂ is of very high purity (99%); after treatment it is brought to 99.995% purity required for food quality.

Evaluation of the incorporated energy

Purification supposes pressurization assumed to be the same as that of transportation, which is 2 MPa. When beginning CO₂ is at atmospheric pressure, so we assume a two-stage compression with a compressor efficiency of 75%, which corresponds to a compression energy of 320 kJ/kg and a

cooling energy of discharge temperature at 30°C made by cooling tower, estimated at 30 kJ/kg from 30°C to -20°C of 135 kJ/kg (cooling system at -25°C with a COP of 2.5), which makes a total of 485 kJ/kg. CO₂ losses, to maintain a constant pressure by compensation of heat losses due to evaporation, should be taken into account but data are missing. So an **apparent COP** is obtained, which supposes that the sublimation latent heat is fully useful. By referring this useful energy to the energy necessary to the dry ice production, it comes:

$$580 / 485 = 1.2$$

If dry ice is used at about -45°C, this COP is close to that of vapor compression systems, but to maintain positive temperatures, the COP is lower of at least a factor 2.5 to 3 compared to vapor compression systems.

To conclude, dry ice is an interesting way for fast transportation of high added-value products. It is also a useful additional means or troubleshooting to maintain temperature-controlled products; these applications are identified and limited.

Refrigeration system using liquid nitrogen

The use of liquid nitrogen is known in food processes to freeze high added-value products such as raspberries or more generally fragile fruits.

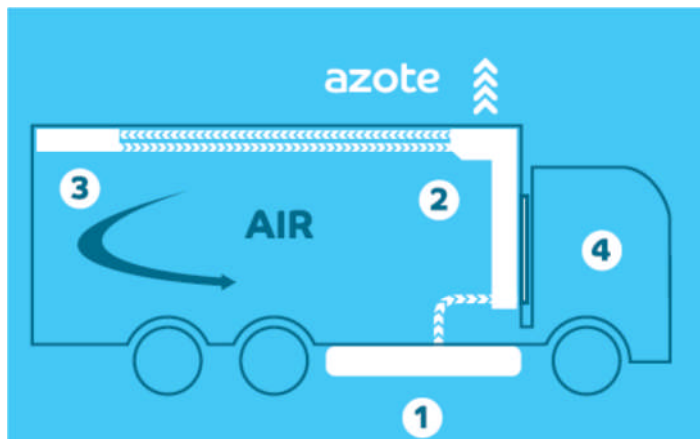

Figure 6.28 Principe lay-out of an indirect refrigeration system (source Air Liquide).

Liquid nitrogen, charged in the reservoir (1) will go through heat-exchanger (2, 3) to transfer its refrigeration capacity before being released outside the system as a gas via a silent system. The air contained in the refrigerated volume is cooled by contact with heat exchangers and diffuses homogeneously in each compartment by means of fans.

Taking into account regulations to come on HFC-type refrigerants, producers of liquid nitrogen such as Air Liquide, Messer or Linde propose refrigeration technologies by liquid nitrogen evaporation for transportation at controlled temperature (see Figure 6.28).

Two concepts co-exist:

- Direct circulation of nitrogen in the refrigeration volume with air vents installed in precise locations, which requires appropriate training of operators to avoid anoxia
- So-called indirect expansion systems, alike the one in Figure 6.28 where the nitrogen cools the air circulating and the evaporated nitrogen is released outdoor so as to avoid any suffocation concentrations in the refrigeration container. One can note that this technology modifies the stakeholder shares and the added-value distribution. Manufacturers of refrigeration containers pick up an added-value on the cold generation that was beyond their control and was going to major actors of mobile refrigeration systems alike Carrier and Thermoking.

From the energy point of view, let us recall that the production of 1 kg of liquid nitrogen requires **2,500 kJ**, its latent heat at -196°C is of **198 kJ/kg** and the sensible heat from -196 to 0°C is of **160 kJ/kg**, which means a COP of $358/2500 = 0.14$ to maintain a product at 0°C, making an energy consumption **30 times higher** than that of a vapor compression system.

The cryogenic refrigeration is justified only because nitrogen is produced fatally with oxygen in a ratio of 1 to 4; therefore there is an excess of nitrogen so that its price does not reflect the energy incorporated. The use of liquid nitrogen will remain of limited use for applications with high added value in the agro-food industries and niches for transport over distances of about 500 km.

References

Air Liquide. Blueeze, le froid cryogénique au service du transport sous température dirigée. Commercial document.

Cold Jet. <http://www.coldjet.com/en/products/dry-ice-production/>

Messer. Le CO₂ solide. Neige et glace carbonique. Commercial document.

Thermo King Cryotech. Groupes frigorifiques propres, silencieux et efficaces. Commercial document.

7. SYNTHESIS OF INTERVIEWS

This section is dedicated to the synthesis of interviews of experts or companies involved either in the design and/or manufacturing of refrigeration equipment or in the operation of these refrigeration installations.

The methodology was based on face-to-face discussions or telephone discussions with key stakeholders. Discussions were conducted according to a defined questionnaire.

7.1 KEY USERS, REPRESENTATIVE ORGANIZATIONS AND RELATED ENTITIES BY SECTOR AND SUB-SECTOR

The list of key stakeholders has been established by members of the consortium that selected 30 stakeholders as follows.

Sector	Type of equipment	Number
Commercial refrigeration	Stand-alone	5
Domestic refrigeration	Remote	2
Commercial refrigeration	Centralized system	5
Food processes	Milk tank	3
Food processes	Warehousing	1
Food processes	Process	3
Prof. Trade union organization		3
Air conditioning		3
Chillers		2
Producers and distributors of refrigerants		3

Interviews have been scheduled and realized from August 1st, 2013 to November 15, 2013. During interviews, companies and organizations have been requested to formalize their statements by giving and providing objective elements confirming their answers, such as:

- Results of previous studies
- Technical listing of installations in operation
- Test reports or expertise by third party or in-house

The detailed list of people met or called is given in Annex 3. Results of detailed questionnaires and formal elements given during the report are not attached to the report because of the request by organizations to keep the data confidential.

7.2 PROFILE OF RESPONDENTS

Profiles of experts participating to the interviews are presented as follows (see Figure 7.1):

- Function in the company (R&D, marketing, CEO)
- Type of represented companies (manufacturer, user)
- Sectors according to the represented segmentation

Consulted inter-professional organizations are classified according to the college they represent (manufacturers for trade unions of manufacturers or installers, and users for trade unions of companies owners of equipment). Some organizations solicited in this study have wished make a synthesis of their own members during common meetings. In this case, this consultation is weighted by the number of representatives that have participated.

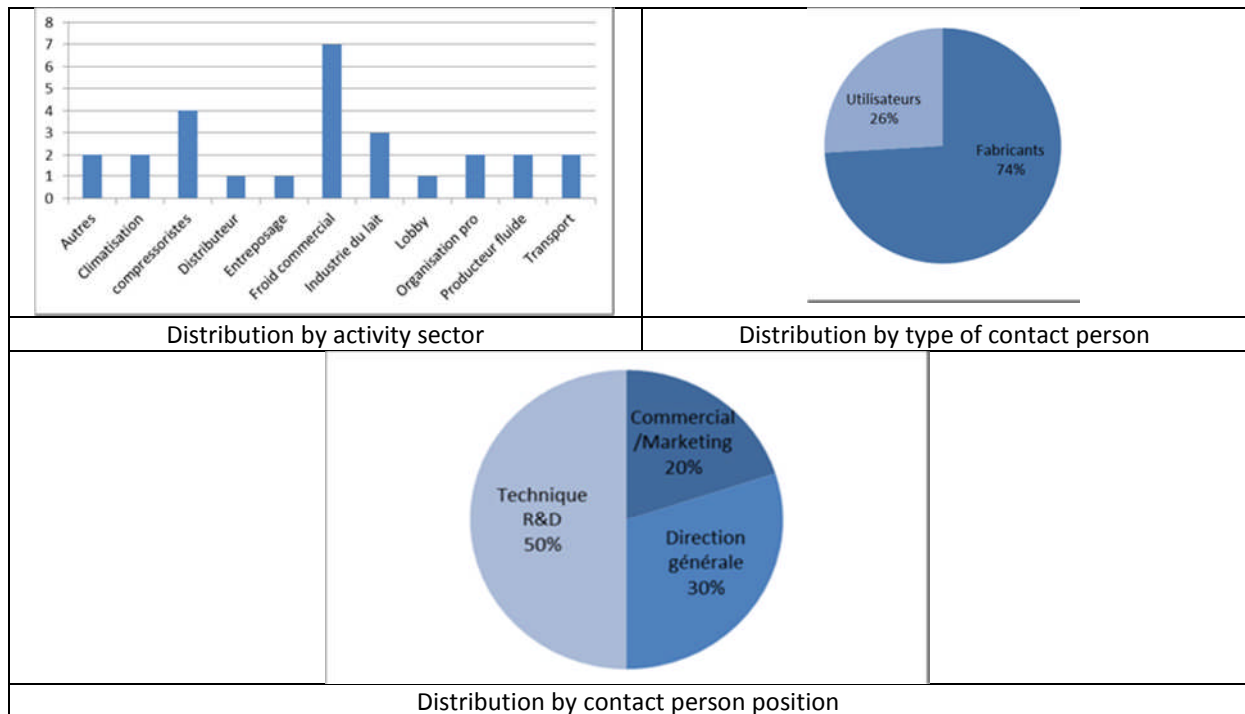

Figure 7.1 Synthesis of interviewed people and organizations.

7.3 RESULTS OF THE SURVEY

Results from the analyses of interviews and provided documents show a contrasted situation of key stakeholders of the refrigeration and air conditioning sector in thoughts related to alternative refrigerants to high-GWP refrigerants. The following major trends appear.

For manufacturers of turnkey solutions:

- Some manufacturers generally unfavorable to the use of low-GWP halogenated fluids for fear that these refrigerants potentially impacted by the F-gas, are merely transitional solutions
- Some manufacturers with little figures on existing alternatives or where development tests have been slowed or halted waiting for the results of the F-gas review
- Some manufacturers stating development phases of alternative solutions potentially quite short (3 to 4 years), including when the mechanical design of equipment (compressor, refrigerant circuit, room) is impacted due to the volumetric capacity of the substitute refrigerant
- Some manufacturers awaiting a clearer regulatory framework on the use of hydrocarbons as refrigerants and a maximum admissible charge with regards to fire risks
- For centralized refrigeration, the strong positioning of CO₂ as alternative for new installations.

For users:

- Users uncertain on the technical choices to be made and having a very limited degree of knowledge on current developments; only federated professionals around an inter-union adopt an approach of technical choice that reflects the particular context of high-GWP refrigerants
- A fear that substitute halogenated refrigerants are only transition refrigerants
- A strong concern regarding the safety of equipment containing hydrocarbons and questions on the level of responsibility of equipment holders in case of accident

- A strong desire for a better acceptance by DREALs of equipment using ammonia; some of which are considered hostile to the deployment of these techniques despite the compliance with installations classified for environmental protection (ICPE) requirements
- The finding of a limited supply in France for ammonia and CO₂

ANNEX 1: CONSORTIUM PRESENTATION

EReIE

EReIE is a young innovative enterprise (JEI) created in December 2010. Its activity is part of the New Energy Technologies (NTE). EReIE valorizes several technologies invented by its founding members and patented by ARMINES, which EReIE is the exclusive licensee.

The EReIE staff is growing fast, 19 employees including 10 doctors in December 2013. EReIE is an RID (Research Innovation and Development) company and also an engineering for the development and realization of Organic Rankine systems, ORC CLEANING® or CRYOPUR® systems, for biomethane purification and liquefaction. EReIE assembles and tests its equipment in its facilities. Finally EReIE maintains a strong internal research activity in conjunction with external laboratories, especially those of MINES ParisTech and performs R & D & D actions for third parties, large companies or SMEs.

EReIE design, build or have built under his supervision all the steps required to go from initial concept to the industrialization of a product or process. EReIE is positioned downstream research laboratories, once the proof of concept was conducted in the laboratory. EReIE builds pilots and demonstrators that will work gradually in the same conditions as real operating conditions. Many of these contracts are confidential because the results belong to the client only.

EReIE has written and follows its quality chart, and prepares its ISO-9001 and ISO-14001 certification.

Studies, inventories, and energy and exergy audits

In-depth knowledge in refrigeration, air-conditioning, heat pumps and ORC systems technologies led EReIE founding members to develop at ARMINES CEP a database, first for France and then for the world, on all refrigeration and air-conditioning equipment. This database, RIEP, allows the realization of inventories of refrigerant banks contained in equipment and so forecast emissions and environmental impacts depending on the molecules in use (HCFCs, HFCs, NH₃, CO₂, HCs ...).

The knowledge of thermodynamic systems, the expertise in exergy analysis and energy integration for industrial processes and for the "building system" constitute bases for the methodology of energy and exergy audits (EEA) performed by EReIE. On this basis and with instrumentation adapted to each sector, EReIE proposed audits analyzing not only utilities but the overall process. This effort of comprehension with experts of the audited enterprise leads to new concepts that generate often ruptures in energy efficiency and even in waste management.

CEMAFROID

Cemafroid is an independent expertise center on the cold and refrigeration chain. It offers to professional the following services:

- tests and verification of equipment,
- regulatory or voluntary certification
- expertise and advice,
- public service,
- training.

Cemafroid realizes tests of equipment and vehicles for the cold chain: packaging, containers, refrigeration units, cold rooms, milk tanks, heat pumps, kitchen equipment, thermometers, recorders, display cases, ... These services are performed in their test and calibration facilities located in Antony (92) and Cestas (33). These laboratories are accredited by COFRAC according to ISO 17025 standard and by WHO.

Cemafruid has a test station ATP approved by the United Nations. As such, it performs tests of new equipment and testing for the renewal of ATP certificates. It is also notified by several ministries to carry out official tests: Ministry of Food, Ministry of Defense, Health, Interior

Cemafruid certifies

- companies for compliance of their products or services in accordance with the standards in force. In particular, it certifies production compliance of manufacturers of transport equipment to enable them to apply directly for ATP certificates. Cemafruid also empowers the test centers for the renewal of transport units at 6 and 9 years.
- within the scope of new European and national regulations, companies for refrigerant handling.

Cemafruid delivers voluntary certification marks in particular the performance Cemafruid mark.

Cemafruid also provides its neutral expertise and advices to stakeholders and their suppliers. This expertise is addressed to professionals of the cold chain, from manufacturers to end-users including transport and storage, refrigeration and air conditioning. The expertise of Cemafruid integrates all components of refrigeration. It covers business needs, equipment selection, validation, use, adjustment or maintenance, energy consumption and field organization and practices.

Cemafruid also offers specific expertise in the development and innovation in support of designers and manufacturers of materials and equipment. At the interface between research, industry and users, Cemafruid assists companies for the industrialization of their solutions.

Since 2009, as part of a delegation of public service, Cemafruid delivers on behalf of the Ministry of Agriculture certificates of technical compliance of refrigeration transport cargos.

More than 25 000 certificates are issued each year to over 110,000 French refrigeration transport vehicles. Database and online application DATAFRIG allow a fully paperless management of these procedures.

The training catalog Cemafruid offers a range of inter-company trainings. It is supplemented by intra-company tailored-made training.

ARMINES CES

The Center Energy Efficiency Systems is a Research Centre MINES ParisTech gathering 75 researchers and PhD students. Specializing in sectors of energy efficiency and decarbonization processes, CES themes are structured around the storage of energy, sustainable cities and buildings, industrial energy, low-emission vehicles, and energy and environmental policies.

Among the five competence teams formed by the CES, the teams of the thermodynamics of systems have the expertise in both technology of refrigeration and air-conditioning equipment and refrigerants. Methodologies and software tools have been developed at CES to allow characterization of refrigerants. Research projects and experimental studies are underway in partnership with producers to characterize and test future low-GWP fluids on different technologies.

In addition, the CES has developed a global database on refrigeration and air-conditioning equipment for over 10 years. It is regularly updated to enable the realization of refrigerant inventories and refrigerant-emission forecast. A software tool, RIEP (Refrigerant Emission Inventories and Forecast) was developed and enriched at the CES in order to carry out these assessment studies. RIEP, coupled with databases, allows the evaluation of existing or potential development of regulations (Tax on HFCs, Evolutions of the F-Gas, mandatory decommissioning of equipment using CFCs and HCFCs, etc..) and the introduction of new refrigerants on equipment markets (France, Europe).

The CES has also conducted several studies of synthesis and analysis of rules and practices at the international level, including the comparative study of refrigerant recovery channels at end of life of equipment on behalf of the AFCE.

ANNEX 2: LIST OF THE CONSORTIUM EXPERTS PARTICIPANTS TO THE STUDY

EReIE Experts

Name and function	Diploma and Education	Experiences and competences	References
<p>Denis CLODIC EReIE President</p>	<p>CNAM engineer Ph.D. in Energy science MINES ParisTech</p>	<p>Currently EReIE president From 1984 to December 2010, 25 years in research at MINES ParisTech of 18 as manager of the Center for Energy and Processes - Paris (80 people)</p>	<p>Chapter Lead author on commercial refrigeration of RTOC since 1996. Chapter Lead author on mobile air conditioning of the IPCC Report, 2005. Co-author of the RAC chapter of IPCC Guideline 2006 on method of refrigerant inventories. Co-author of all ARMINES reports on refrigerant inventories in France since 1996 and co-author of three reports on global refrigerant inventories. Member of the Academy of technologies RTOC member</p>
<p>Xueqin PAN Project leader</p>	<p>Ph.D. in Energy science MINES ParisTech Engineer in cryogenics, University of Zhejiang (China)</p>	<p>Xueqin PAN currently holds a position as project manager within EReIE. In 2009, she joined ARMINES CEP, where she was in charge of flue-gas cleaning within the project on CO₂ capture from a power generation unit. In 2007, she joined the R&D department of ACE Industry as Head of Products of ROOFTOP service. In 2004, she joined the engineering service of Trane, as responsible for the design and development of a new range of world-oriented air conditioning products.</p>	<p>AIRWELL, TRANE, SHERPA ENG., ARMINES, Company of domestic equipment in Hangzhou, China</p>

Experts Cemafruid

Name and function	Diploma and Education	Experiences and competences	References
<p>Gérald CAVALIER Tecnea President- Cemafruid Manager</p>	<p>Polytechnicien (X90) ENGREF engineer (93-95) Chef engineer of Ponts, des Eaux et des Forêts</p>	<p>Gérald Cavalier began his career in 1995 assistant manager and director at the Departmental Directorate of Agriculture and Forestry of the Upper Rhine and as advisor of the prefect, before taking charge in 1999 Cemagref international relations, research organization on agriculture and the environment.</p> <p>In 2002 he became director of the development of group Ruas, 20 M €, 250 people, SME in water supply and public services; he created and led several subsidiaries of the company in developing strongly the business.</p> <p>In 2005 he became head of the GIE Cemafruid which has tripled its turnover in five years to reach € 4.2 million in 2010.</p> <p>Gérald Cavalier is Chairman of the Committee transportation of the International Institute of Refrigeration and Cold Chain Committee Health Products of AFF and SFSTP. He is an expert with the UNECE, CEN, WHO and International Transfrigoroute.</p>	<p>Institut International of Refrigeration, French Refrigeration Association, IFTIM, Groupe Ruas, Cemagref, DDAF 68 et 30, AFNOR, Transfrigoroute France and International</p>
<p>Eric DEVIN Director of Operations – President of Cemafruid Formation</p>	<p>Engineer, University Paris XI – Orsay Field « Sciences Materials engineering »</p>	<p>Eric Devin began his career in the National Testing Laboratory (LNE), responsible for testing and thermal metrology laboratories, Chief of the Legal Metrology division for 5 years. He actively participated in the opening of the European market under the new directive approach. In late 2007, Eric DEVIN joined Cemafruid to contribute to its development, especially in the sector of certification, leading Cemafruid on top of accredited bodies on refrigerants.</p> <p>Eric Devin is active member of the French Refrigeration Association, which he is chairman of the Ile de France Committee, Chairman of the Subcommittee CERTE within the IIR dedicated to transport and vice-president of the UNECE WP11 for ATP regulation. It also participates in the French Committee of Metrology and is a board member of the AFCE. He coordinates the Datafluides consortium grouping four approved organizations for certificates of capacity and involving over 12,000 companies in France</p>	<p>Ministère de l'industrie (DARQSI), MEED, CECOD, OIIML, WELMEC, ISO, CEN, AFNOR, syndicat de la mesure, UNECE, Institut International du Froid, Association Française du Froid, Transfrigoroute France</p>

<p>Thomas MICHINEAU</p> <p>Development engineer</p>	<p>MBA in Marketing and Strategy, Ecole Supérieure de Commerce Extérieur (ESCE), IAE Poitiers</p> <p>Ecole Polytechnique of Nantes University (EPUN) Thermal Departement – Energy, Option Refrigeration Air conditioning</p>	<p>Thomas Michineau began as Deputy Head of Scientific and Technical Information Department, International Institute of Refrigeration (IIR). During this assignment, he met most international experts of the refrigeration sector and participated in numerous conferences. He joined the Cemafruid in 2012 where he was in charge of various studies (market study on alternatives to compression units in transport, study on commercial refrigeration facilities, magnetic refrigeration, European study. He manages the project for the implementation of the Cemafruid new test platform (ammoniac CO₂).</p>	<p>EDF, IIR, EU</p>
<p>Florence MOULINS</p> <p>Engineer expertise advice</p>	<p>Strategic Marketing INM-IFG</p> <p>Diplôme supérieur du Froid Industriel IFFI-CNAM</p> <p>BTS Froid et Climatisation</p>	<p>Director prescription France and Deputy Director Marketing and Sales Director Sanyo OEMS in TECUMSEH EUROPE, Florence was then responsible for sales and distribution products in ACAL SA and chief engineer and technical and commercial air conditioning in TOSHIBA SYSTEMS SA before joining Cemafruid.</p> <p>Member of the French Association of Refrigeration (AFF), Florence is AFNOR certified inspector to inspect heat pumps and air conditioning systems. She is involved in many assignments to support project management, energy audits of retrofits, retro commissioning in France and Europe.</p>	<p>SANYO, TECUMSEHEUROPE, ACAL SA, TOSHIBA SYSTEMES SA,AFF</p>

Experts Armines

Nom et Fonction	Diplômes et Formations	Expériences et compétences	Références
<p>Stéphanie BARRAULT</p> <p>Research engineer</p>	<p>Ph.D. in Energy science MINES ParisTech</p> <p>Engineer ESTACA</p>	<p>Since 2002, Stéphanie Barrault is Research engineer for the CES MINES ParisTech / ARMINES.</p> <p>She is in charge of annual studies of refrigerant emissions inventories for metropolitan France and DOM COM. She is also in charge of studies of refrigerant-emission previsions and assessment of refrigerants regulations. She participated in the development of computational tool SceGES on behalf of the Ministry of Ecology. She is a member of AFCE since 2007.</p> <p>Previously, she was successively engineering research within the scientific computing division and Project Engineer in Division New Vehicle Concepts at PSA Peugeot Citroën.</p>	<p>CES Mines-ParisTech/ ARMINES</p> <p>ADEME</p> <p>MEDDE/direction générale de l'énergie et du climat</p> <p>CITEPA</p> <p>PSA PEUGEOT-CITROEN</p>

ANNEX 3: LIST OF COMPANIES INTERVIEWED WITHIN THE SCOPE OF THE STUDY

BEE
Schecco
Copeland US
Tecumseh europe
Bitzer
Danfoss
Arkema
Dupont Honeywell
Perifem
Carrier transicold
Thermoking
Daikin
Johnson Control
AHT
EPTA Refrigeration
ACFRI
FRIAX
Fritec
Profroid
Vauconsant
Packo Inox
PANEM
POMONA
DeLaval
SERAP

ANNEX 4: LIST OF REPORTS AND PUBLICATIONS USED WITHIN THE SCOPE OF THE STUDY

Datafrig : database for the refrigerated transport sector
Inventory of the bank of refrigerants realized by ARMINES each year
EIA Chilling Facts V Report: RETAILERS ON THE CUSP OF A GLOBAL COOLING REVOLUTION
Impact study MEDDE 2012 (Bureau VERITAS)
Fridoc IIR database (International Institute of Refrigeration)

- [ARE12] AHRI (Air-Conditioning, Heating & Refrigeration Institute) Low-GWP Alternative Refrigerants Evaluation Program.
http://www.ahrinet.org/ahri+low_gwp+alternative+refrigerants+evaluation+program.aspx
- [BAR12] Barrault, S., Saba, S., Clodic, D., 2012: Inventaire des Emissions des fluides frigorigènes FRANCE - Année 2011. Rapport final pour le MEDDTL. Décembre 2012.
- [CLO11] Clodic, D., Barrault, S., Pan, X. Septembre 2011. 1990 to 2010 Refrigerant inventories for Europe and prevision on banks and emissions from 2010 to 2030. Report for EPEE (European Partnership for Energy and the Environment).
- [DEV12] Les entrepôts et leur activité en 2012. Observation et Statistiques. Chiffres et statistiques. Commissariat Général au Développement Durable, N° 334 Juillet 2012.
- [MAR13] System Drop-In Tests of Refrigerant Blends L-40, DR-7 and ARM-30a in a Trailer Refrigeration Unit Designed for R-404A, Marketa Kopecka, Michal Hegar, Vladimir Sulc, Jeff Berge, Thermo king corporation, Rapport AREP/AHRI, Janvier 2013
- [PAN12] Panorama des industries agroalimentaires, édition 2012. Ministère de l'agriculture, de l'agroalimentaire et de la forêt.
- [PER13] Note de synthèse : Alternatives crédibles en réfrigération commerciale. PERIFEM, 23 Janvier 2013.
- [RAJ13] Rajan Rajendran Bangkok Technical Conference 2013
- [SCH11] Schwarz et al., 2011, 'Preparatory study for a review of Regulation (EC) No 842/2006 on certain fluorinated greenhouse gases', Öko-Recherche et al.
- [SKM12] Phase Down of HFC Consumption in the EU - Assessment of Implications for the RAC Sector. Final report. August 2012. SKM Enviro.
- [TOC11] 2010 Report of the Refrigeration, Air conditioning and Heat Pumps Technical Option Committee. 2010 Assessment. UNEP, February 2011.
- [ZOU13] Fluides frigorigènes alternatifs: état des lieux en agro-alimentaire. Assaad Zoughaib, CES MINES-ParisTech, Colloque AFCE 2013.

ANNEX 5: LIST OF REGULATORY TEXTS

- Regulation EC 842/2006
- Directive 97/23/EC « Pressure equipment directive »
- Order of 15 March 2000 related to the operation of pressure equipment (modified by orders of 13 October 2000 and 30 March 2005)
- Rubrique ICPE n°2920 : “Réfrigération or compression (installations of) operating at effective pressures higher than 10^5 Pa”
- Rubrique ICPE n°1136 B : “Use of ammonia”
- Rubrique ICPE n°2921 : “Cooling by water dispersion in an air flow (installations of)”
- Order of 14 February 2000 on the approval of dispositions supplementing and amending Regulation safety against the risks of fire and panic in establishments open to the public
- DIR 09 Directive 2009/125/EC of the EU Parliament and of the Council of 21 October 2009 establishing a framework for the setting of ecodesign requirements for energy-related products
- MeeRp 2011. Methodology for Ecodesign of Energy-related Products. MEERP 201. Final Report. Part 2: Environmental policies and data. Report for the European Commission, DG Enterprise and Industry. Contract SI2.581529.
- REG 12 Commission Regulation (EU) No 206/2012 of 6 March 2012 implementing Directive 2009/125/EC of the European Parliament and of the Council with regard to ecodesign requirements for air conditioners and comfort fans.

ANNEX 6: LIST OF STANDARDS AND RECOMMENDATIONS

- NF EN 378-1 2008: Refrigeration systems and heat pumps - Safety and environment requirements – Part 1: basic requirements, definitions, classifications and criteria of choice
- NF EN 378-2 2008: Refrigeration systems and heat pumps - Safety and environment requirements – Part 2: Design, construction, tests, marking and documentation
- NF EN 378-3 2008: Refrigeration systems and heat pumps – Safety and environment requirements – Part 3: Installation in situ and protection of persons
- NF EN 378- 2008: Refrigeration systems and heat pumps – Safety and environment requirements – Part 4: Operation, maintenance, repair and recovery
- NF EN 13136: Refrigeration systems and heat pumps – Overpressure devices and associated piping
- NF EN 10216-2 (P265GH): Tubes without steel welding for pressure service
- CODAP 2000: Code for the construction of pressure equipment
- CODETI 2001: Code for the construction of industrial piping
- RECOMMENDATIONS OF THE C.N.A.M. (29 November 1983)

ANNEX 7: VALUES OF GWPs OF REFRIGERANTS

GWPs are given for their values at 100-year horizon of integration.

Type	Name	Composition or Formula	GWP ₁₀₀ kg eq. CO ₂			
			2 nd	3 rd	4 th	TOC 2011
HCFC	HCFC-22		1 500	1 700	1 800	1 790
HCFC	R-123		90	120	77	77
HFC	HFC-152a					133
HFC	HFC-125					3 420
HFC	HFC-143a					4 180
HFC	HFC-32					716
HCFC	R-408A	HFC-125/143a/22 (7/46/47)	2 650	3 015	3 200	3 200
HCFC	R-401A	HCFC-22/152a/124 (53/13/34)	970	1 130	1 200	1 200
HFC	HFC-134a		1 300	1 300	1 430	1 370
HFC	R-404A	HFC-125/143a/134a (44/52/4)	3 260	3 785	3 900	3 700
HFC	R-407C	HFC-32/125/134a (23/25/52)	1 525	1 655	1 800	1 700
HFC	R-407F	HFC-32/125/134a (30/30/60)				2063
HFC	R-410A	HFC-32/125 (50/50)	1 730	1 975	2 100	2 100
HFC	R-417A	HFC-125/134a/600 (46.6/50/3.4)	1 955	2 235	2 300	2 300
HFC	R-422A	HFC-125/134a/600a (85.1/11.5/3.4)	2 535	2 895	3 100	3 100
HFC	R-422D	HFC-125/134a/600a (65.1/31.5/3.4)	2 235	2 625	2 700	2 700
HFC	R-427A	HFC- 32/125/143a/134a (15/25/10/50)	1 830	2 015	2 100	2 100
HFC	R-507AA	HFC-125/143a (50/50)	3 300	3 850	4 000	3 800
HCFO	R-1233zd					6
HFO	R-1234yf	CH ₂ =CFCF ₃				4
HFO	R-1234ze	CHF=CHCF ₃				6
HC	R-600a		20	20	20	4
HC-290	R-290	CH ₃ CH ₂ CH ₃				6*
HC-1270	R-1270	CH ₃ CH=CH ₂				2*
NH ₃	R-717		0	0	0	<1
CO ₂	R-744		1	1	1	1

Name	Formula	GWP (TOC 2011)
ARM-30a	HFC-32/1234yf (29/71)	210
ARM-31a	HFC-32/134a/1234yf (28/21/51)	490
ARM-32	HFC-32/125/134a/1234yf (25/30/25/20)	1 548
ARM-42a	HFC-134a/152a/1234yf (7/11/82)	114
ARM-70	HFC-32/134a/1234yf (50/10/40)	497
D-52Y	HFC-32/125/1234yf (15/25/60)	965
DR-5	HFC-32/1234yf (72,5/27,5)	520
DR-7	HFC-32/1234yf (36/64)	260
D2Y-60	HFC-32/1234yf (40/60)	289
D2Y-65	HFC-32/1234yf (35/65)	253
HPR-1D	HFC-32/744/1234ze (60/6/34)	432
L-20	HFC-32/152a/1234yf/1234ze (40/10/20/30)	302
L-40	HFC-32/152a/1234yf/1234ze (40/10/20/30)	302
L-41a	HFC-32/1234yf/1234ze (73/15/12)	524
L-41b	HFC-32/1234ze (73/27)	524
LTRAX	HFC-32/125/134A/1234ze (28/25/16/31)	1 277
LTR6A	HFC-32/744/1234ze (30/7/63)	219
N13a	HFC-134a/1234yf/1234/ze (42/18/40)	579
XP-10	HFC-134a/1234yf (44/56)	605

ANNEX 8: COMPARISON OF THE SEGMENTATION ADOPTED WITH THAT PROPOSED BY SKM [SKM12]

The classification SKM is close of that adopted for inventories. It is form a critical analysis of propositions made by EReE/ARMINES reports [CLO11] and Oko-Recherche [OKO12]. In some sectors, SKM distinguishes sub-categories depending on the temperature level (industrial refrigeration) or of the reversibility (chillers and heat pumps).

Description of SKM factsheets

- SKM proposes one factsheet by sector, which defines one standard model 2010 and for which available or possible alternatives in 2012 are mentioned. Specific case, when the standard is not a high-GWP refrigerant, the factsheet presents alternatives to other HFCs used in the sector (i.e.: domestic refrigeration).
- The “standard 2010” model is defined by the refrigerant used, the average charge, the average capacity, and the COP. Compositions of the bank and of the new market are given (% refrigerants). Levels of emissions in 2010 are mentioned. The part of imported pre-charged and charge refill on site are evaluated. The installed base and the market of equipments are evaluated for 2010 and 2030. Except the refrigerant, all these characteristics are not given for alternatives. Average costs in 2010 are defined for systems in terms of investment cost (“capital”), lifetime, expenses in €/yr related to energy consumption and maintenance.
- For them, the alternative is a refrigerant, not another system (no mention of indirect expansion systems) nor another technology. A recapitulative table, in % compared to a given reference (HFC or HCFC-22), the investment, energy consumption, and maintenance additional costs. The availability date is mentioned. No mention on possible retrofits. No alternative description.

Main differences between AFCE report and that of SMK

COMMERCIAL REFRIGERATION

For stand-alone in small stores ("Small Hermetic") two cases are distinguished: medium and low temperatures. They are characterized by the same refrigerants (HFC-134a), charge (240 g), refrigerating capacity (0.8 kW), only the COP differs among their data: from 2.1 for medium temperature (MT) and 1.2 for low temperature (LT). In 2012, they consider the same available alternatives: R-600a and CO₂.

For condensing units of small stores ("Single condensing units"), similarly, two temperature levels are considered. They consider that the standard system operates with R-404A and characteristics are different according to the temperature levels.

	Charge (kg)	P _{average} (kW)	COP	Existing alternatives
MT	3,6	5	2,2	HFC-134a, R-407A, R-407F
LT	2,7	2	1,2	R-407F

For centralized systems, they consider "Large Multipack", basic unitary system in centralized installation, with two temperature levels:

MT (C_{average} = 100 kg) et LT (C_{average} = 200 kg).

TRANSPORT

- SKM collects self-powered systems of road transport and marine containers
- SKM does not mention reefers.

INDUSTRIES

SKM distinguishes:

- Direct expansion systems considering LT/MT temperature levels and, each time, three sizes of installations (small 20 to 30 kW / medium 80 to 100 kW / large 300 to 400 kW)

Direct expansion systems Alternatives R-404A	Low temperature	Medium temperature
Small	R-407A or F	HFC-134a / R-407A or F
Medium	R-407A or F	HFC-134a / R-407A or F
Large	R-407A or F, NH ₃ , CO ₂	R-407A or F, NH ₃ , CO ₂ , -134a

- chillers (medium and large)
- flooded-evaporator systems (medium and low temperatures)

SKM does not mention industrial processes other than food processes.

SAC and HPs

SKM groups in the same sector air-to-air conditioners and heat pumps and distinguishes for most of equipments reversible from non-reversible. This distinction does not seem very useful since characteristics are identical, except heating specifications, and available or possible alternatives as well as difference costs and availability are the same. So, in the SKM study, proposed categories are as follows:

- movables
- small splits (P = 3.5 kW, C = 0.8 kg)
- small splits reversible (P = 3.5 kW, C = 1.2 kg) -> same alternatives and same cost differences as non-reversible splits
- medium-size non-reversible splits (P = 7,5 kW, C = 2 kg)
- medium-size reversible splits (P = 7,5 kW, C = 2.5 kg) -> same alternatives and same cost differences as non-reversible splits
- large-size non-reversible splits (P = 14 kW, C = 5.6 kg)
- large-size reversible splits (P = 14 kW, C = 5.6 kg) -> same alternatives and same cost differences as non-reversible splits
- "packaged systems" (P = 80 kW, C = 20 kg) reversible and include rooftops and "ducted splits of P > 12 kW"
- "packaged systems" (P = 80 kW, C = 20 kg) non-reversible and include rooftops and "ducted splits of P > 12 kW" -> here again, same alternatives and same difference costs for reversible and non-reversible
- non-reversible VRV
- reversible VRV -> here again, same alternatives and same difference costs for reversible and non-reversible.

So SKM differentiates 6 categories of splits when the AFCE study considers only two (splits for individual air conditioning, with P < 17.5 kW and multi-splits of P < 17.5 kW). Only HFC-32 is identified as a possible alternative for all splits. For large splits, "blend 700" is supposed to be available one day. For others, it is also considered a blend with GWP around 300 available between 2015 and 2018

Ducted splits are included in splits and multi-splits of more than 17.5 kW -> structure adapted to that of French statistics.

The small category of "cabinets" is not mentioned.

Air-to-water, water-to-air, water-to-water, ground source HPs are considered with chillers ("hydronic heat pumps").

CHILLERS.

SKM takes into account, as in this report, three capacity ranges, including screw and scroll compressors, and although refrigerants used are identical, differentiates "air cooled" from "water cooled" on one part and on the other part, heating equipment alone, which is equivalent to 10 categories of water HPs and chillers.

SKM categories	P cold/ Photd (kW)	Cmy (kg)	COP	Refrigerant	Market equipt EU2010	Available alternatives <i>Future</i>
Small capacity chiller "cooling only air cooled"	100	29	3.1	R-410A	48,000	HFC-134a, HFC-32, HC <i>Blend 300, 700, 1234ze.</i>
Medium capacity chiller "cooling only air cooled"	500	150	3.6	HFC-134a	10,000	HFC-32, NH ₃ , HC <i>R-1234ze, blend300 et 700</i>
Large capacity chiller "cooling only air cooled"	1200	360	3.8	HFC-134a	1,000	HFC-32, NH ₃ , HC <i>R-1234ze, blend300 et 700</i>
Small capacity chiller "cooling only water cooled"	100	29	5	R-410A	1,400	HFC-134a, HFC-32, HC <i>Blend 300, 700, 1234ze.</i>
Medium capacity chiller "cooling only water cooled"	500	150	5.5	HFC-134a	1,200	HFC-32, NH ₃ , HC <i>R-1234ze, blend300 et 700</i>
Large capacity chiller CENTRIFUGAL "cooling only water cooled"	2 500	750	6.4	HFC-134a	650	HFC-32, R-1234ze <i>DR2/N12, Blend300&700</i>
Air-to-water HPs heating only domestic use	15	4,4	2.9	R-410A	240,000	HFC-134a/HFC-32 <i>Blend300&700</i>
Air-to-water HPs heating only – Medium size	100	29	2.9	R-410A	6,000	HFC-134a/HFC-32 <i>Blend300&700</i>
Air-to-water reversible HPs, small size	100 <i>100</i>	29	3.1 2.5	R-410A	11,000	HFC-134a/HFC-32 <i>Blend300&700 & HC</i>
Air-to-water reversible HPs, medium size	500 <i>500</i>	150	3.6	HFC-134a	2,100	HFC-32 <i>Blend300&700, HC</i>

This table shows that "water cooled" categories are little representative of new market and present same characteristics and alternatives as "air cooled" and also the same difference costs in (%). There is no real interest in their differentiation. We find almost the same categories as those in inventories for chillers ("large cooling only water cooled" corresponding to centrifugal), but low limits and high power are different.

For HPs, SKM mentions 4 categories of water-to-water HPs but no differentiation between ground-to-ground, ground water, and water-to-water. Alternatives are always similar, with cost and availability levels identical, which would tend to show that there is no interest to distinguish them also.

MOBILE AIR CONDITIONING CLIMATISATION

Includes systems for buses and trains, without taking into account R-407C systems for trains.

ANNEX 9: SECTOR ANALYSIS OF BANKS AND DEMANDS FOR MAINTENANCE OF REFRIGERATION AND AIR-CONDITIONING INSTALLATIONS OF THE FRENCH INSTALLED BASE

A9 – 1 R-404A AND R-507AA

Commercial refrigeration and industrial refrigeration are the largest consumers of R-404A (Figure A9.1).

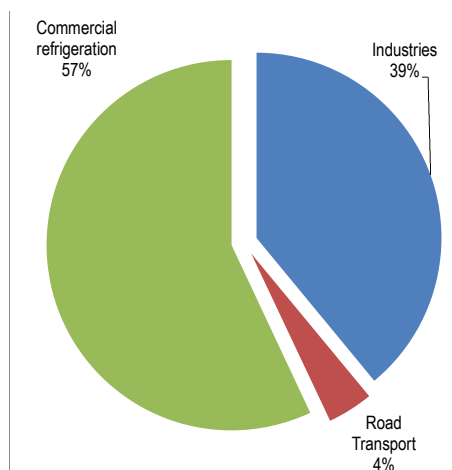

Figure A9.1 Sector structuration of R-404A (and R-507A) bank in France 2011

Results by sub-sector (Figure A9.2 and Table A9.1) show that R-404A (and R-507A) bank is dominated by the centralized commercial refrigeration (large supermarkets 25% and supermarkets 19%) and food processes (17%). Warehouses and condensing units used in small stores constitute also a significant R-404A bank (more than 800 t each).

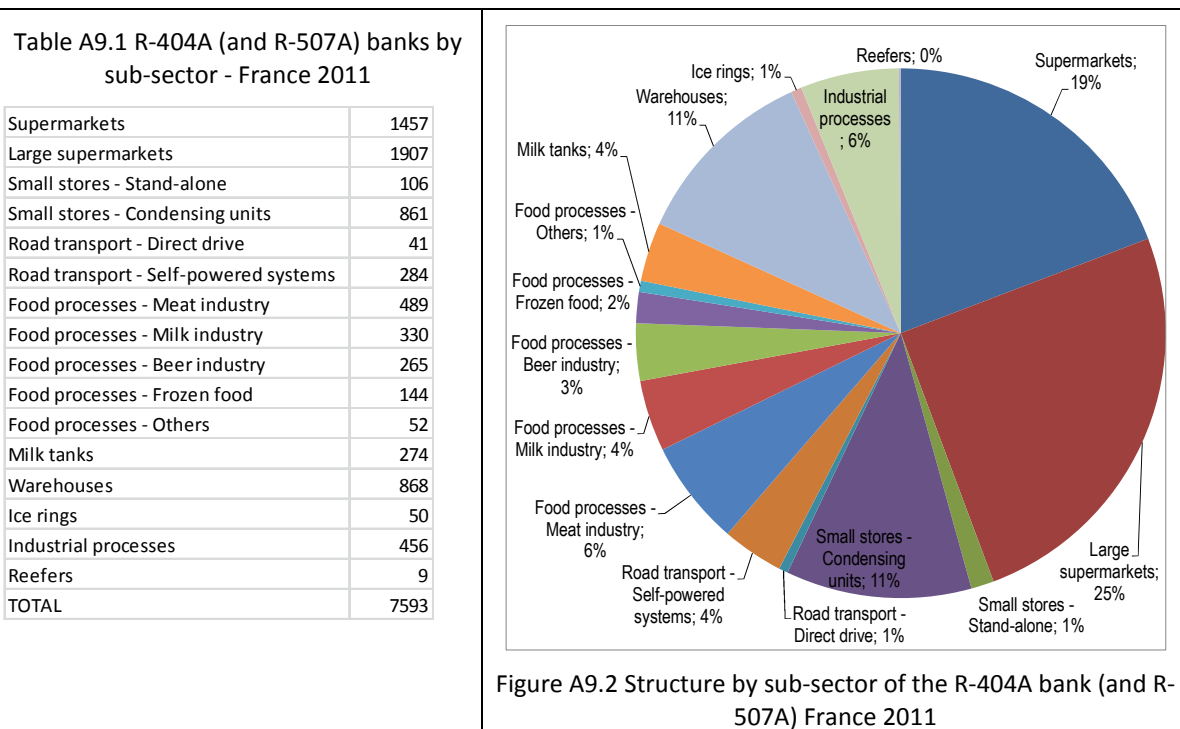

Figure A9.2 Structure by sub-sector of the R-404A bank (and R-507A) France 2011

R-404A demand for maintenance of equipments is dominated by two third by commercial refrigeration (Figure A9.3).

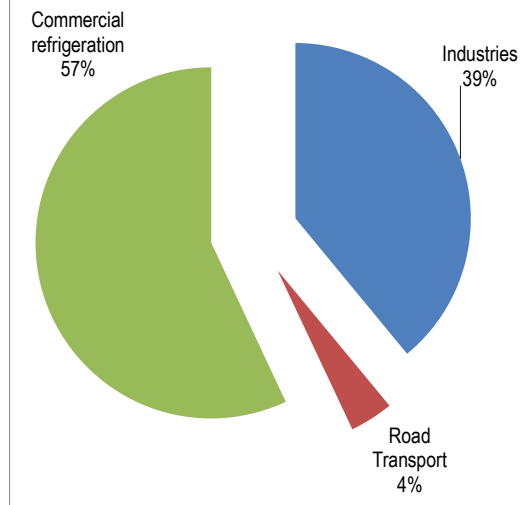

Figure A9.3 Sector distribution of R-404A demand (and R-507A) necessary to the maintenance of equipments included in the French installed in 2011.

Results by sub-sector (Figure A9.4 and Table A9.2) show that R-404A demand for maintenance (and R-507A) is dominated by large supermarkets at 36%. Demand is also high in supermarkets (21%) and food processes (13%).

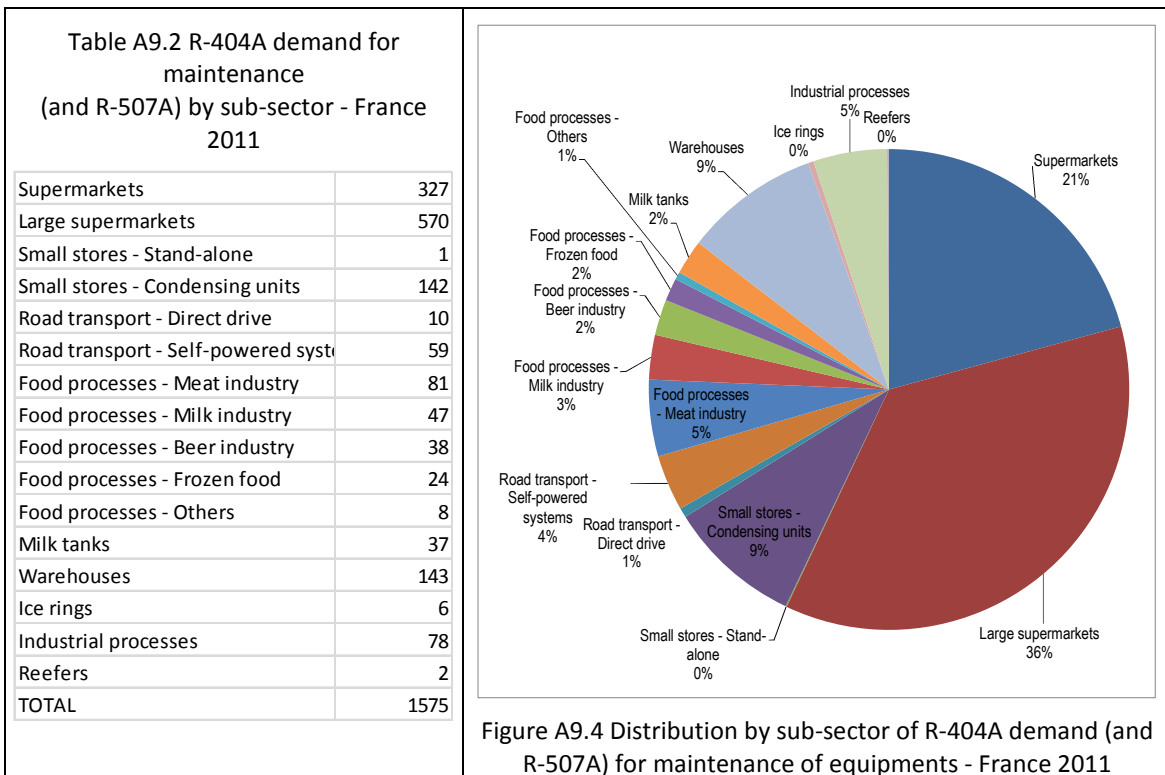

Figure A9.4 Distribution by sub-sector of R-404A demand (and R-507A) for maintenance of equipments - France 2011

A9 – 2 R-410A

Stationary air conditioning is the sector using most R-410A. It represents 60% of R-410A French bank. The heat pump sector (HP) is in strong development and represents 26% of the R-410A French bank in 2011 (Figure A9.5).

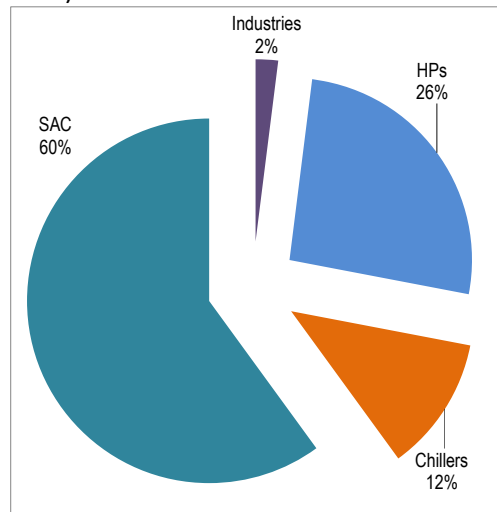

Figure A9.5 Sector distribution of R-410A bank - France 2011

Results by sub-sector (Figure A9.6 and Table A9.3) show that R-410A bank is dominated by that of split-type applications, 27 %, and air-to-water HPs, 17%, and multi-splits, 14%.

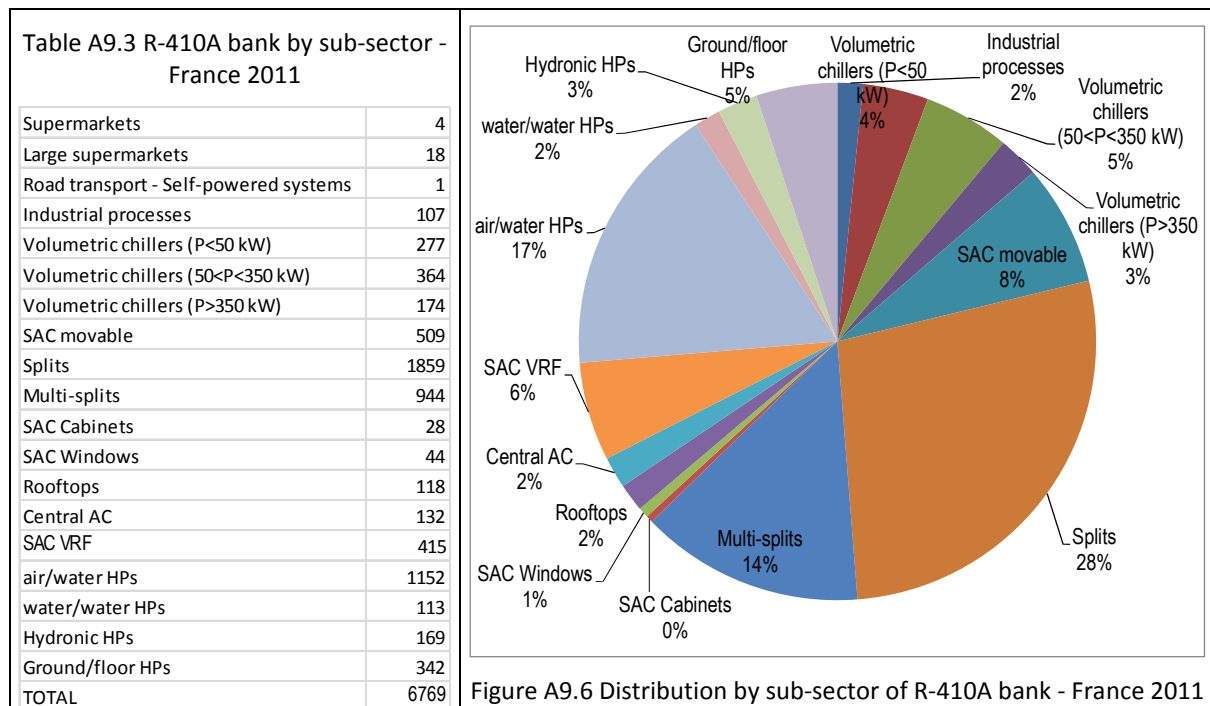

Figure A9.6 Distribution by sub-sector of R-410A bank - France 2011

R-410A demand for maintenance of equipments is relative low, in the range of 330 t in 2011. They are dominated by two third by stationary air conditioning. Emission rates of HPs being lower, the demand for maintenance is low for this sector.

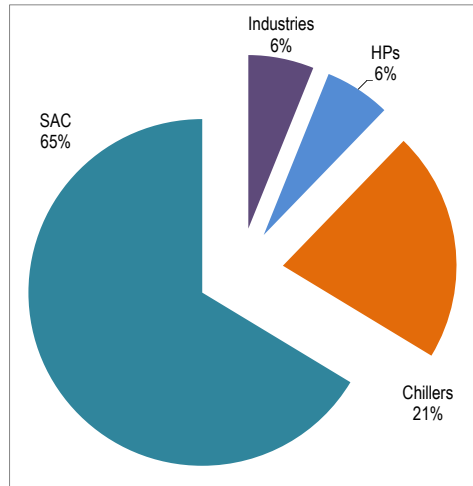

Figure A9.7 Distribution by sector of R-410A demand for maintenance of equipments of the French installed base in 2011.

Results by sub-sector (Figure A9.8 and Table A9.4) show that split-systems and multi-split applications dominate the R-410A demand for maintenance of equipments in 2011. (To be noted, this demand oscillates as a function of years).

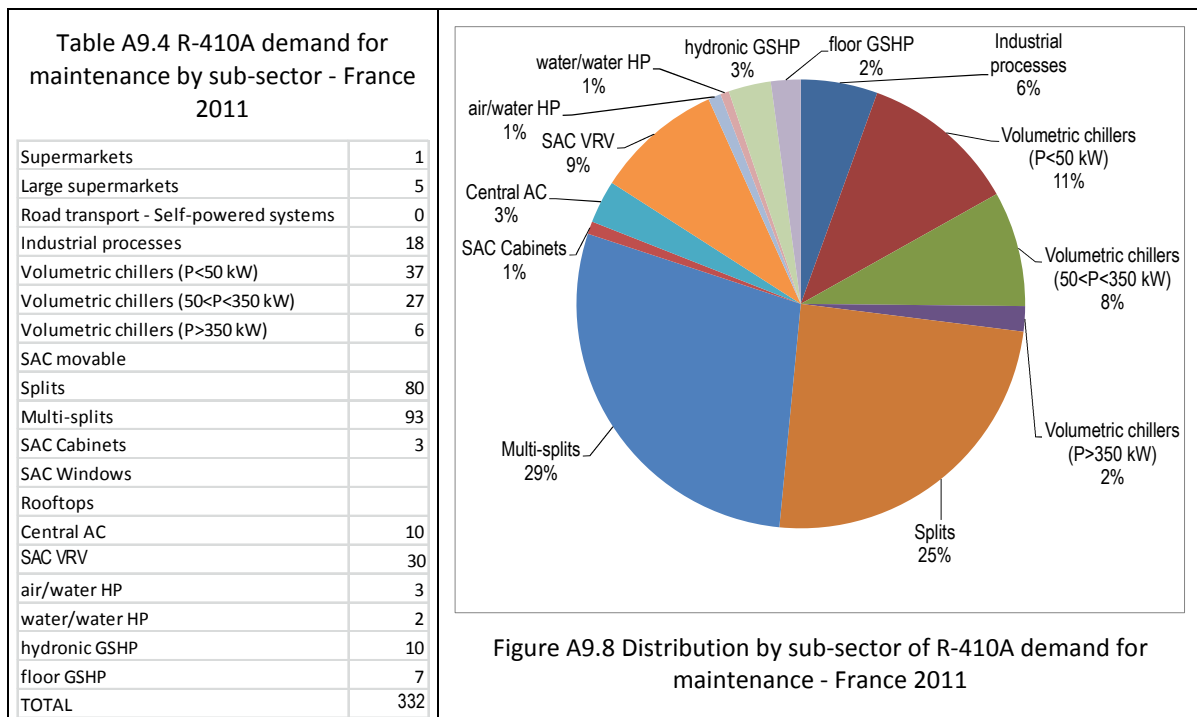

Figure A9.8 Distribution by sub-sector of R-410A demand for maintenance - France 2011

A9 – 3 R-407C

Chillers are the sector using most R-407C. Its bank represents more than half of the French bank of R-407C.

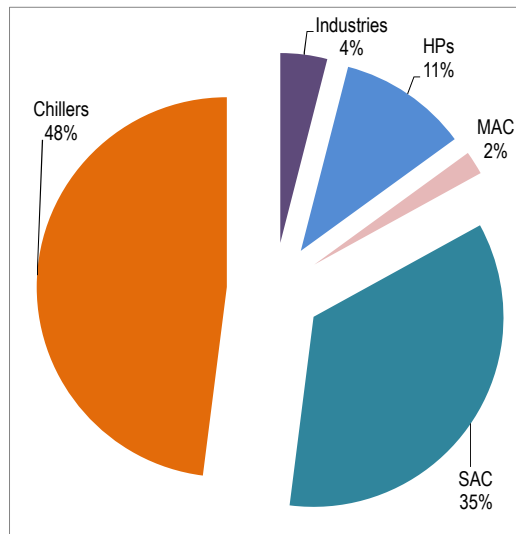

Figure A9.10 Distribution by sector of R-407C bank - France 2011

Results by sub-sector (Figure A9.11 and Table A9.5) show that R-407C bank is dominated by high-capacity volumetric chillers at 28%. R-407C banks of medium-capacity chillers, splits and multi-splits represent also significant parts (from 9 to 15%).

Table A9.5 R-407C bank by sub-sector - France 2011

Supermarkets	3
Large supermarkets	3
Industrial processes	236
Volumetric chillers (P<50 kW)	230
Volumetric chillers (50<P<350 kW)	787
Volumetric chillers (P>350 kW)	1477
Splits	573
Multi-splits	493
SAC Cabinets	23
Rooftops	330
Central AC	34
VRV	391
air/water HP	231
water/water HP	40
hydronic GSHP	115
floor GSHP	168
trains	80
TOTAL	5213

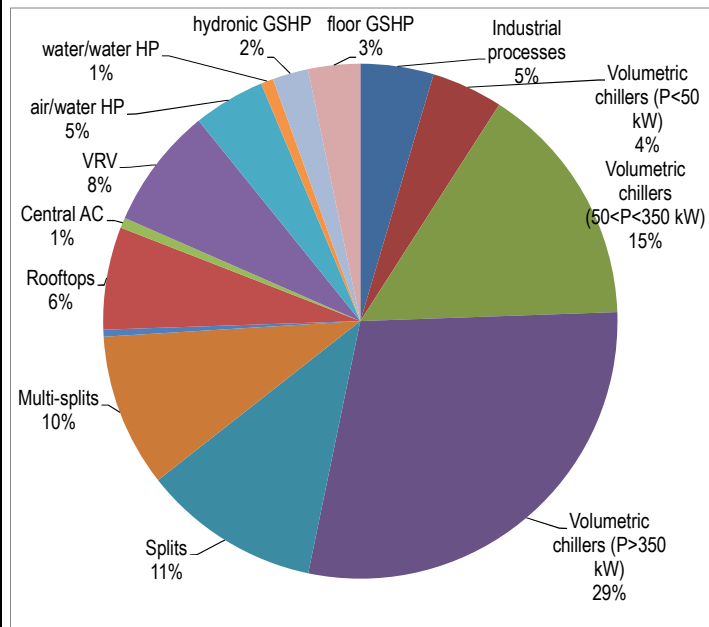

Figure A9.11 Distribution by sub-sector of the R-407C bank - France 2011

The R-407C demand for the maintenance of the French installed base is strongly related to the sector of chillers (Figure A9.12).

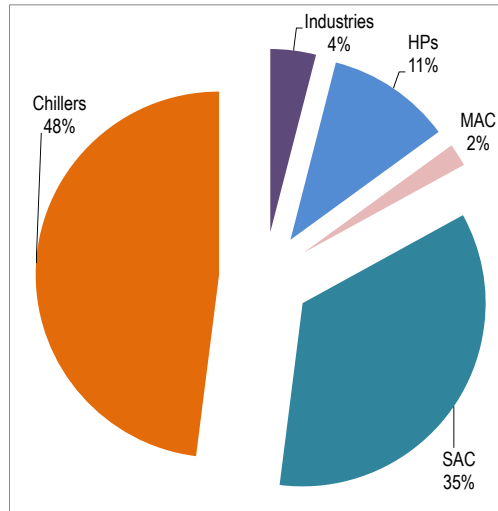

Figure A9.12 Distribution by sector of R-407C demand necessary to the maintenance of equipments of the French installed base in 2011.

The level of the demand for the maintenance of the French installed base is in the range of 460 t of R-407C in 2011. Results by sub-sector show that high-capacity chillers, medium capacity and multi-splits cover more than half of this demand.

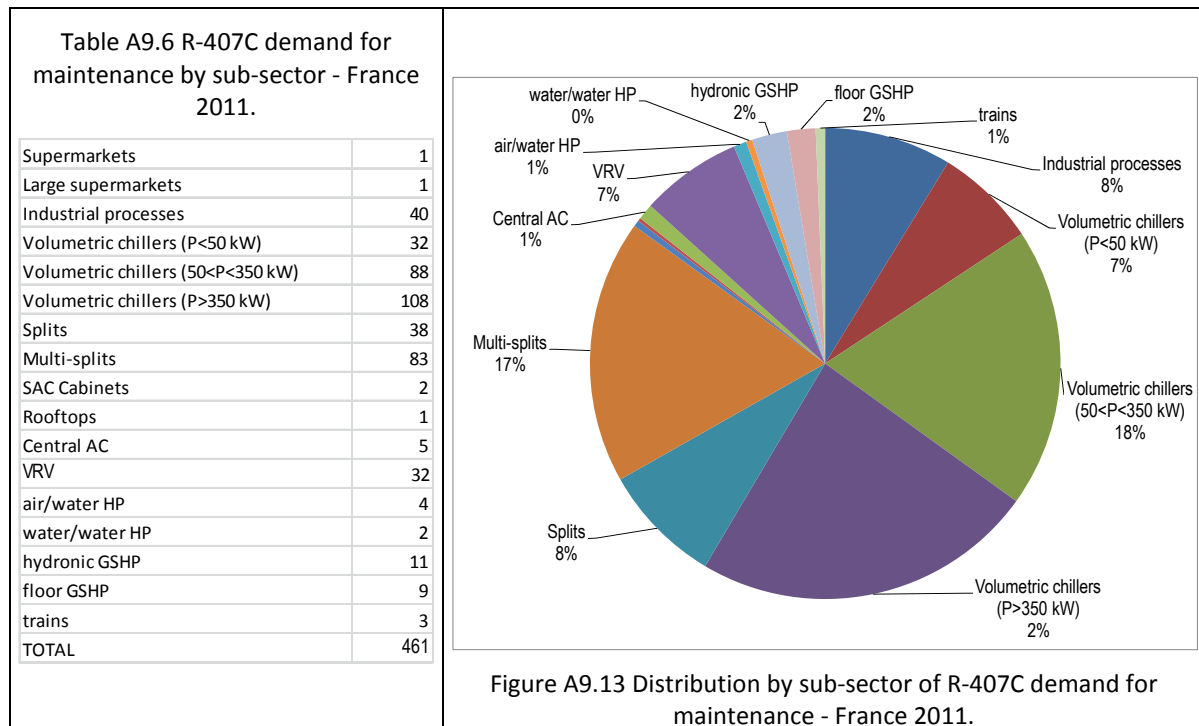

Figure A9.13 Distribution by sub-sector of R-407C demand for maintenance - France 2011.

A9 – 4 HFC-134a

Two-third of the HFC-134a French bank are dominated by the mobile air conditioning sector (Figure A9.14). Chillers, domestic and industrial refrigeration, are main users of the remaining third.

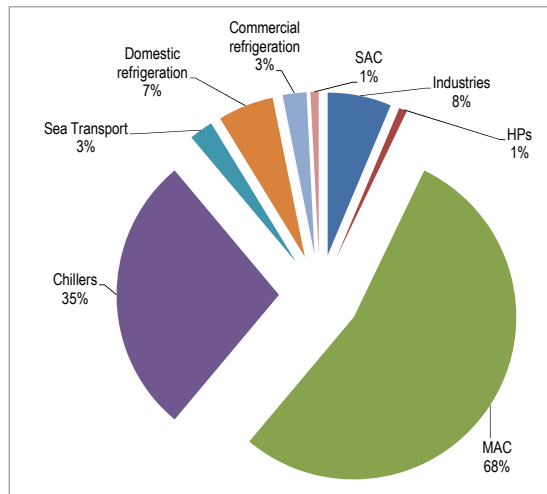

Figure A9.14 Distribution by sector of the HFC-134a bank - France 2011

Figure A9.15 and Table A9.7 give the distribution by sub-sector.

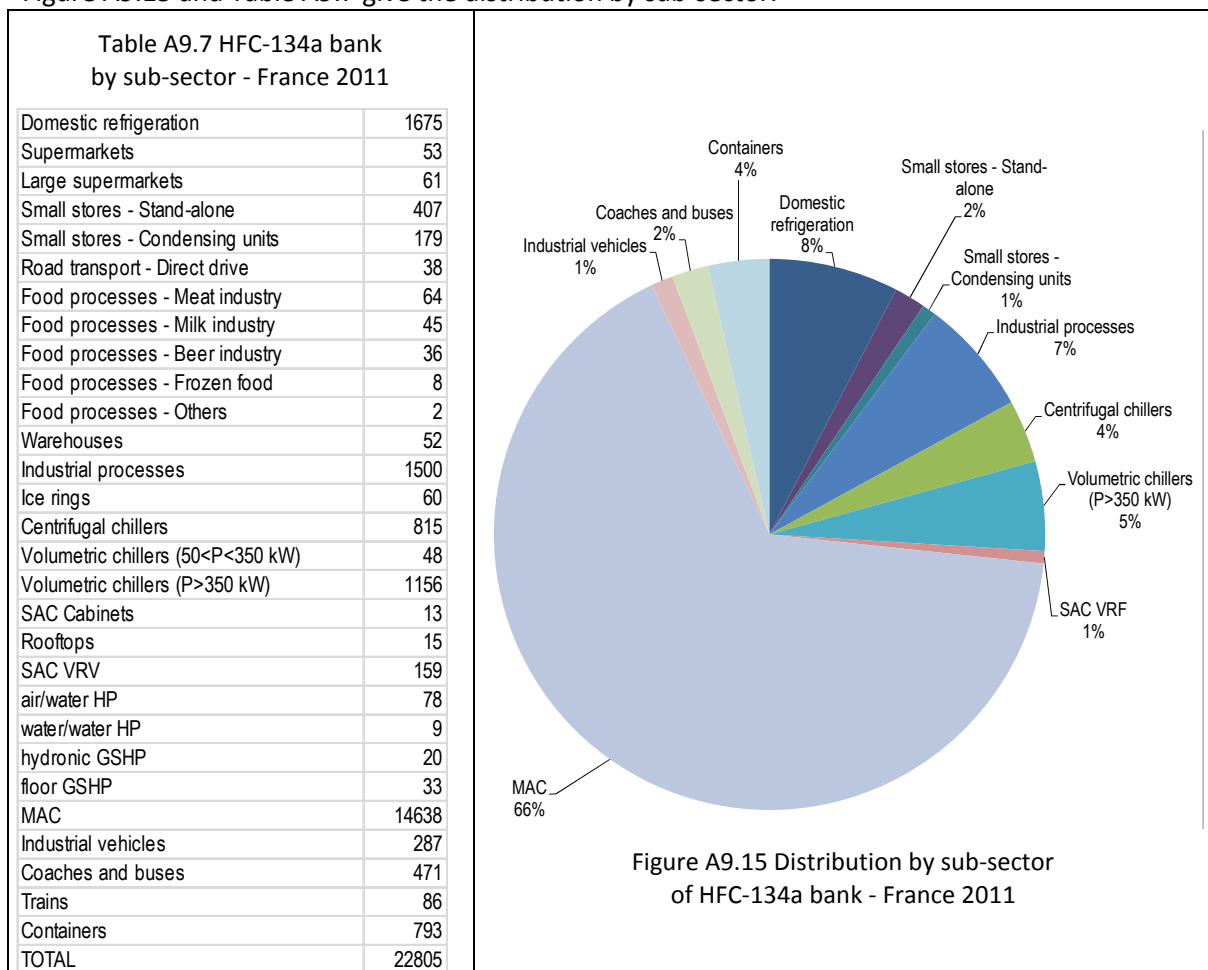

Figure A9.15 Distribution by sub-sector of HFC-134a bank - France 2011

HFC-134a is used in a number of applications, in small quantities. Except mobile air conditioning, they are sub-sectors of domestic refrigeration, high-capacity chillers and industrial processes that use most HFC-134a in 2011.

In terms of maintenance, the HFC-134a demand is also dominated by the mobile air-conditioning sector, nearly 50%. Then the demand concerns industrial refrigeration, sea transport, and chillers.

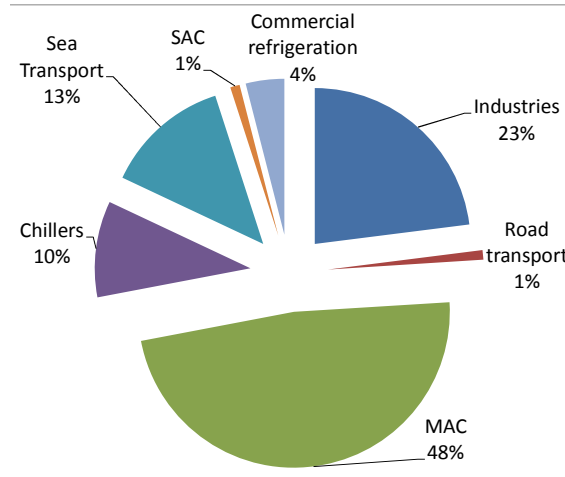

Figure A9.16 Distribution by sector of HFC-134a demand necessary to the maintenance of equipments constituting the French installed base in 2011.

The demand level for the maintenance of the French installed base is in the range of 1,500 t of HFC-134a in 2011, of which one third for mobile air conditioning. Results by sub-sector show that industrial processes, refrigerated containers and coaches and buses cover nearly half of the HFC-134a demand.

Table A9.8 HFC-134a demand for maintenance by sub-sector - France 2011

Domestic refrigeration	0
Supermarkets	12
Large supermarkets	18
Small stores - Stand-alone	5
Small stores - Condensing units	30
Road transport - Direct drive	12
Food processes - Meat industry	11
Food processes - Milk industry	6
Food processes - Beer industry	5
Food processes - Frozen food	1
Food processes - Others	0
Warehouses	9
Industrial processes	295
Ice rings	9
Centrifugal chillers	77
Volumetric chillers (50<P<350 kW)	0
Volumetric chillers (P>350 kW)	72
SAC Cabinets	1
Rooflops	1
SAC VRV	11
air/water HP	0
water/water HP	0
hydronic GSHP	2
floor GSHP	1
MAC	531
Industrial vehicles	21
Coaches and buses	167
Trains	9
Containers	187
TOTAL	1474

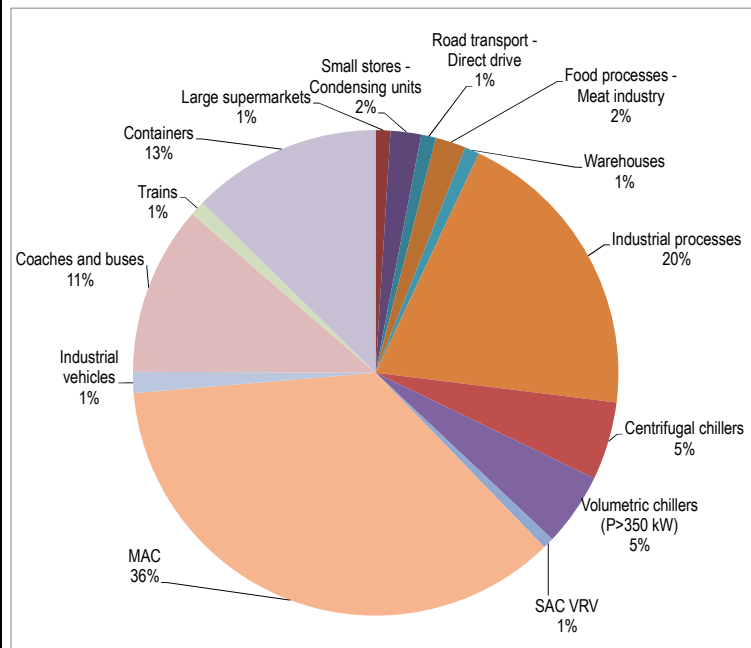

Figure A9.17 Distribution by sub-sector of the HFC-134a demand for maintenance - France 2011